

FREE ZONE

Design C.R.S. Boffi

Sistema modulare di contenitori sospesi senza maniglia.

L'impugnatura (e l'apertura) dei frontali avviene grazie alla presenza della fascia maniglia montata sulla parte superiore del mobile.

I contenitori sono disponibili con 3 differenti sistemi di apertura dei frontali: A BATTENTE / ESTRAIBILE / SCORREVOLE COMPLANARE.

Piano (1)

Piano squadrato allestibile con lavabi sopra piano da appoggio, sopra piano da incasso, sottopiano da incasso o filopiano stampato.

SPESSORE: 15 - 20 - 23 mm.

PROFONDITÀ: 500 mm.

Contenitore (2)

Realizzato in pannelli di particelle di legno di spessore 19 mm, idrofughi (classe V100), a basso contenuto di formaldeide (classe E1 / CARB P2) nobilitato con carte ad alta grammatura trattate con resine melamminiche. Bordo anteriore e posteriore in ABS in tinta.

ALTEZZA FIANCO: 300 - 470 mm (entrambe compatibili con incasso di lavabi Boffi sopra piano da incasso / sottopiano da incasso / filopiano stampato).

PROFONDITÀ FIANCO: 470 mm.

PROFONDITÀ CON FRONTALE: 495 mm.

LARGHEZZA MODULO A BATTENTE / ESTRAIBILE: 300 - 450 - 600 - 900 - 1200 mm.

LARGHEZZA MODULO SCORREVOLE COMPLANARE: 1200 - 1500 - 1800 - 2100 - 2400 mm.

Fascia maniglia (obbligatoria) (3)

In alluminio verniciato.

COLORE: bianco / nero.

Rivestimento per fascia maniglia (optional) (4)

Realizzato in finitura. Spessore variabile a seconda della finitura.

Da incollare o incollata alla fascia maniglia in alluminio.

SPESSORE: max 20 mm.

Cassetti (5)

Sistema LEGRABOX, con spondine laterali e posteriore in metallo verniciato in colore nero opaco. Fondo in nobilitato nero. Frontale cassetti interni in finitura contenitore.

Ante e frontali (6)

Tutte le finiture escluso VETRO_AMX / ALLUMINIO PLUS_AMX / DE CASTELLI_AMX A-B-C / COMPOSITO_AMX / STONE_AMX A-B-C-D-E.

Realizzate in finitura, spessore 23 mm.

Ante e frontali (7)

VETRO_AMX / ALLUMINIO PLUS_AMX / DE CASTELLI_AMX A-B-C / COMPOSITO_AMX / STONE_AMX A-B-C-D-E

Realizzate con pannello frontale in finitura montato su cornice AMX in alluminio anodizzato nero. Spessore 18+23 mm (nominale).

Pannelli terminali (8)

Realizzati in finitura, spessore 23 mm. (Spessore 20 mm per pietra / marmo / granito).

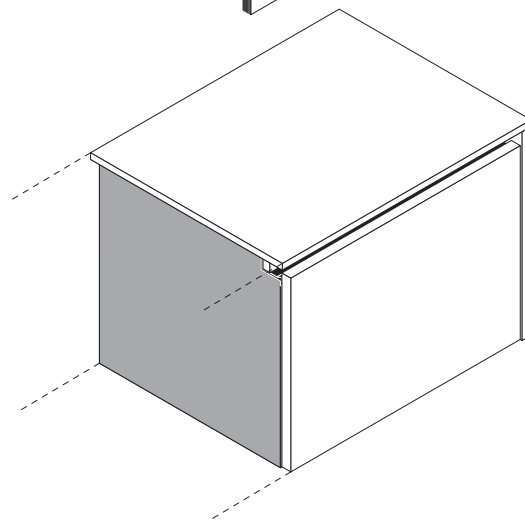
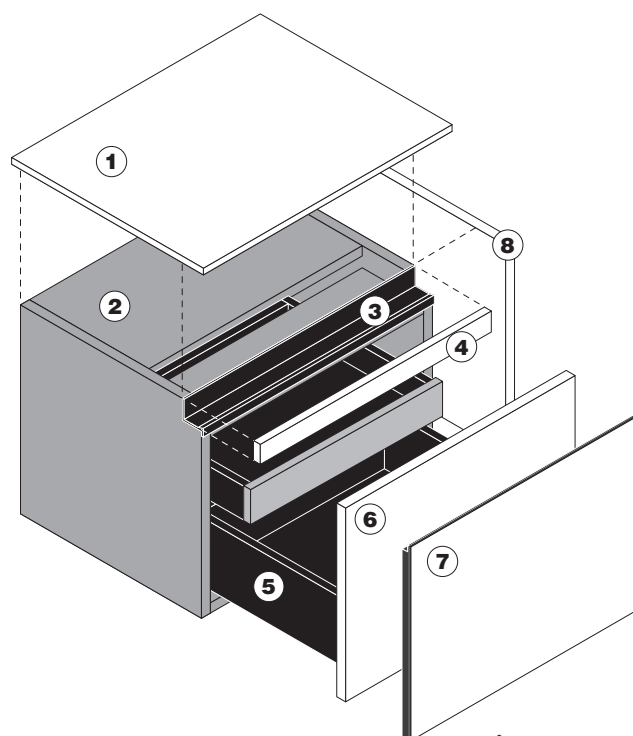



FINITURA
FRONTALI

COLORI / ESSENZE

EASYLAK+

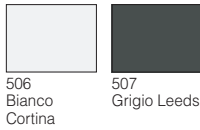
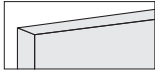

LASERMAT

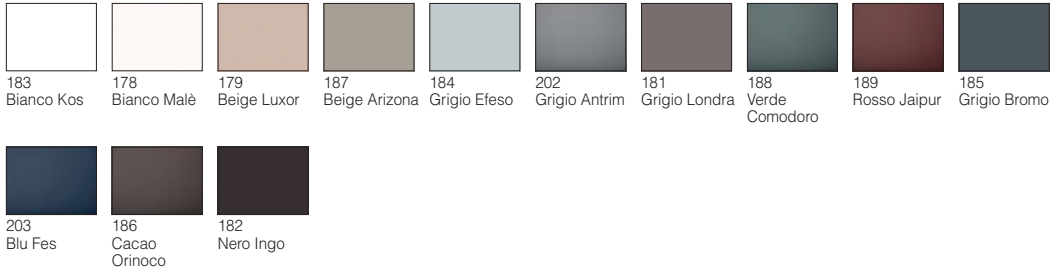
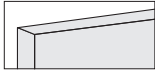

ECOLAK

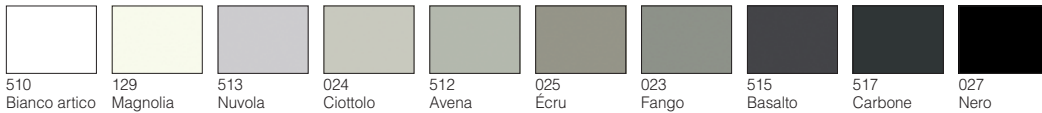

SILCOLAK

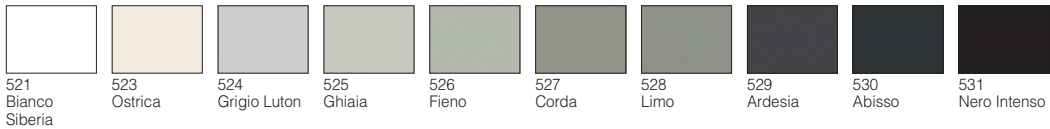
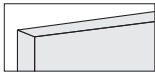

LEGNO

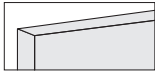

POLIESTERE

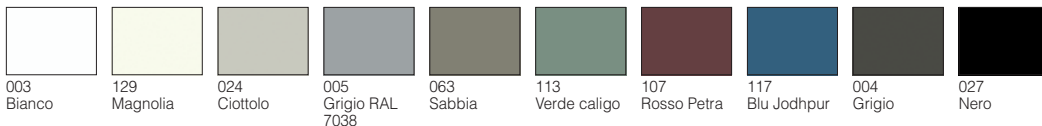
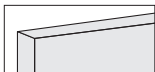

METALS

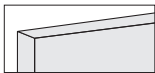

LEGNO SELECTION



CORIAN®



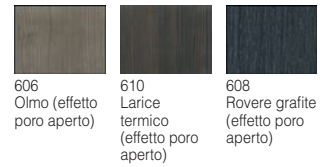

FINITURA
FRONTALI

COLORI / ESSENZE

LEGNO 3D

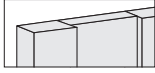

VETRO_AMX

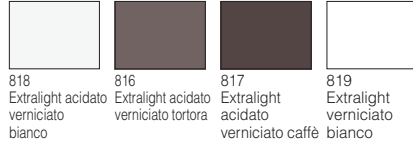

LEGNO MASSELLO

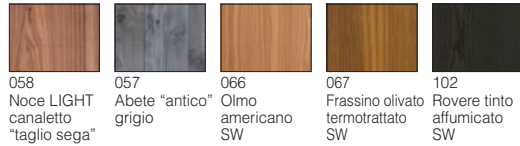

LEGNO MASSELLO 3D

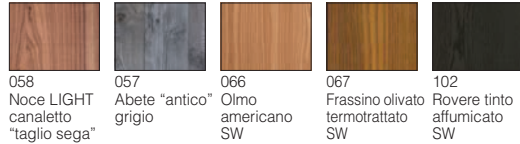
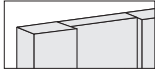

LEGNO MASSELLO FREEHAND

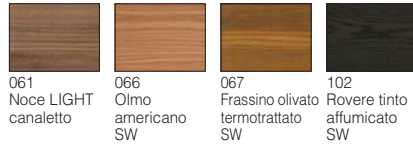
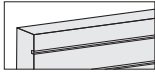

LEGNO MASSELLO SHADES

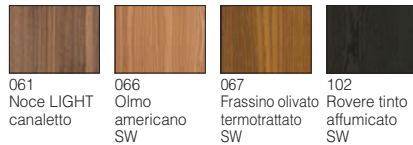
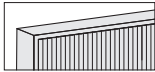

LEGNO EXCLUSIVE

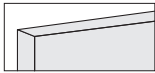

ALLUMINIO PLUS_AMX

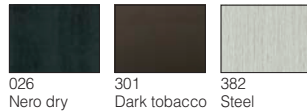

METALLO DE CASTELLI_AMX

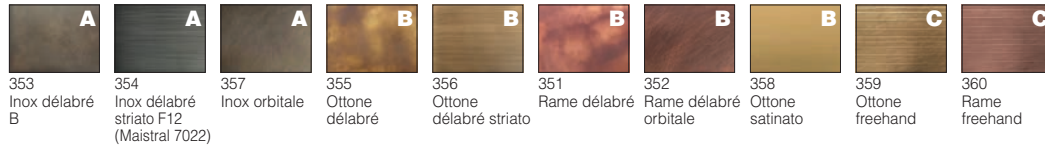

COMPOSITO DEKTON®_AMX

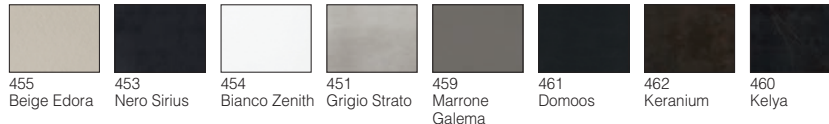



606
 Olmo (effetto
 poro aperto)



610
 Larice
 termico
 (effetto poro
 aperto)



608
 Rovere grafite
 (effetto poro
 aperto)

FINITURA
 FRONTALI

COLORI / ESSENZE

COMPOSITO MDI_AMX



231
 Devon



232
 Surrey

PIETRA - MARMO - GRANITO_AMX



240
 Marmo bianco
 Carrara



199
 Granito Nero
 Assoluto
 Zimbabwe



257
 Quartzite
 Silver



261
 Marmo
 Emperador
 Dark



254
 Granito Black
 Cosmic



259
 Quartzite
 Calacatta



260
 Marmo Grey
 Stone



266
 Marmo bianco
 Carrara
 Lithoverde®



265
 Marmo Gris
 du Marais
 Lithoverde®



267
 Pietra d'Avola
 Lithoverde®



270
 Marmo
 Bianco
 Carrara RAW



268
 Pietra Crema
 d'Orcia RAW



269
 Pietra d'Avola
 RAW



FINITURA PIANI COLORI / ESSENZE

LAVABI

CRISTALPLANT® - H 15 mm

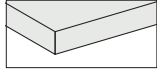

Bianco



LASERMAT - H 20 mm

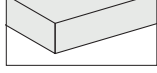

183
Bianco Kos



178
Bianco Malè



179
Beige Luxor



187
Beige Arizona



184
Grigio Efeso



181
Grigio Londra



202
Grigio Antrim



185
Grigio Bromo



203
Blu Fes



188
Verde
Comodoro



186
Cacao
Orinoco



182
Nero Ingo



189
Rosso Jaipur



CORIAN® - H 20 mm

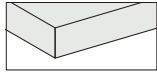

173
Bianco



PIETRA - MARMO - GRANITO - H 20 mm

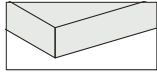

240
Marmo bianco
Carrara



250
Pietra Serena



199
Granito Nero
Assoluto
Zimbabwe



257
Quartzite
Silver



261
Marmo
Emperador
Dark



254
Granito Black
Cosmic



259
Quartzite
Calacatta



260
Marmo Grey
Stone



273
Pietra d'Avola



272
Marmo Gris
du Marais



274
Pietra Crema
d'Orcia.



266
Marmo bianco
Carrara
Lithoverde®



267
Pietra d'Avola
Lithoverde®



265
Marmo Gris
du Marais
Lithoverde®

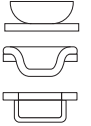

COMPOSITO DEKTON® - H 20 mm

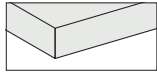

455
Beige Edora



453
Nero Sirius



454
Bianco Zenith



451
Grigio Strato



459
Marrone
Galema



461
Domoos



462
Keranium



460
Kelya

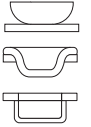

COMPOSITO MDI - H 12 mm

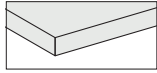

231
Devon



232
Surrey

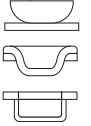

LEGNO MASSELLO - H 23 mm

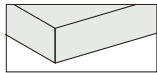

058
Noce LIGHT
canaletto
"taglio sega"



057
Abete "antico"
grigio



066
Olmo americano
SW



067
Frassino olivato
termotrattato
SW



102
Rovere tinto
affumicato
SW



FREE ZONE

Design C.R.S. Boffi

Wall hung, modular units without handle.

The doors are gripped (and opened) through the specific handle-rail, mounted on the upper part of the cabinet.

Three different door opening methods: HINGED / PULL-OUT / COPLANAR SLIDING.

Top (1)

The square-edged tops can be fitted with top-mounted, built-in, under-mounted or moulded flush-mounted washbasins.

THICKNESS: 15 - 20 - 23 mm

DEPTH: 500 mm

Unit (2)

It's made of 19 mm thick wood particle board panels, waterproof (class V100), with low formaldehyde emission (class E1/CARB P2), treated with high performance melamine resin. Front and back edges in ABS, same colour.

SIDE PANEL HEIGHT: 300 - 470 mm (both compatible with built-in / under-mounted / moulded flush-mounted Boffi washbasins).

SIDE PANEL DEPTH: 470 mm.

DEPTH INCLUDING DOOR: 495 mm.

HINGED/PULL-OUT MODULE WIDTH: 300 - 450 - 600 - 900 - 1200 mm.

COLPANAR SLIDING MODULE WIDTH: 1200 - 1500 - 1800 - 2100 - 2400 mm.

Handle-rail (compulsory) (3)

In painted aluminium.

Colour: white / black.

Covering for handle-rail (optional) (4)

Finished. The thickness changes accordingly to finish.

To be glued or glued to the aluminium handle rail.

THICKNESS: max 20 mm

Drawers (5)

LEGRABOX series with sides and back in varnished matt black metal. Bottom in black melamine. Front of internal drawers in same finish as carcass.

Doors and front panels (6)

All finishes except for GLASS_AMX / ALUMINIUM PLUS_AMX / DE CASTELLI_AMX A-B-C / COMPOSITE_AMX / STONE_AMX A-B-C-D-E.

Finished, thickness 23 mm.

Doors and front panels (7)

GLASS_AMX / ALUMINIUM PLUS_AMX / DE CASTELLI_AMX A-B-C / COMPOSITE_AMX / STONE_AMX A-B-C-D-E

Finished front panel mounted on AMX frame in black anodised aluminium. Thickness 18+23 mm (nominal).

End panels (8)

They are in finish, 23 mm. thick (20 mm thick for stone / marble / granite panels).

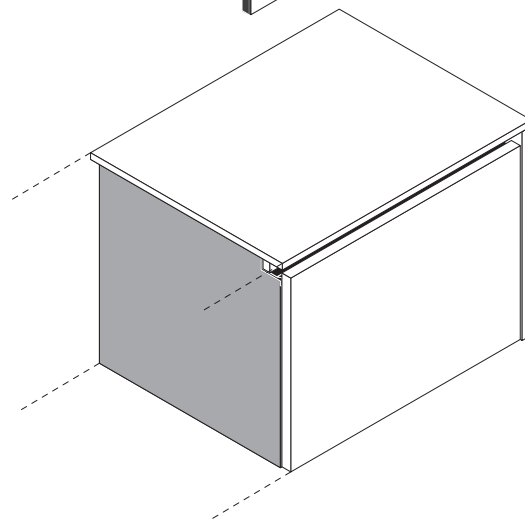
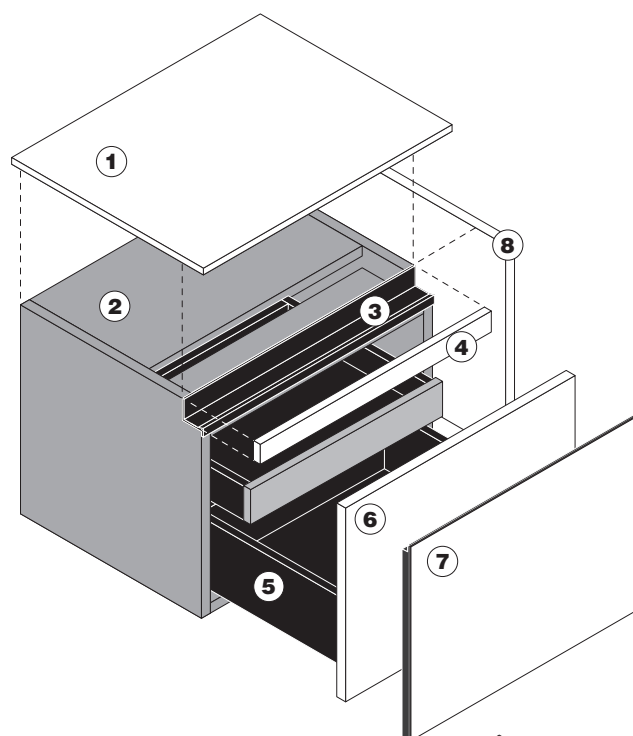

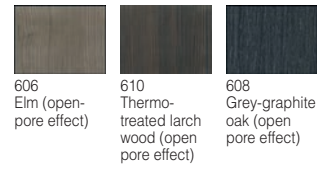

FRONT PANELS
FINISH

COLOURS / SPECIES

EASYLAK+

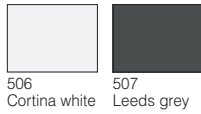
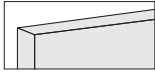

LASERMAT

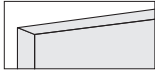

ECOLAK

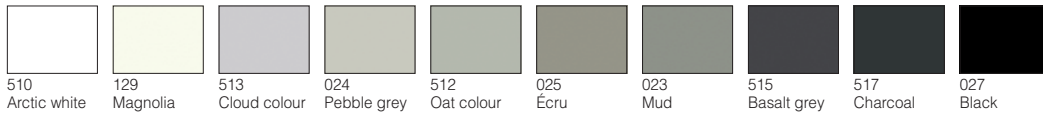
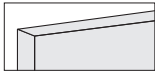

SILCOLAK

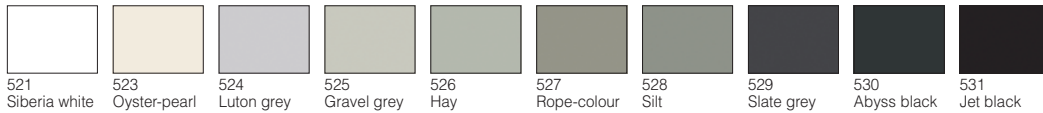
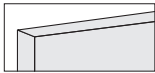

WOOD

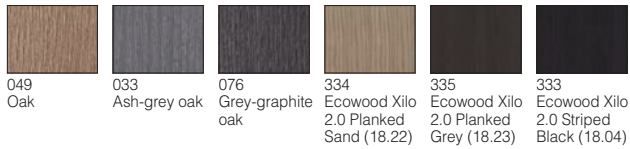
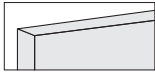

POLYESTER

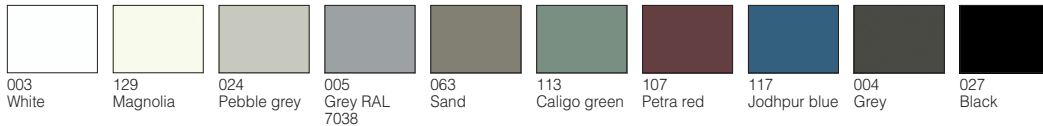
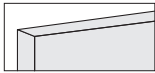

METALS

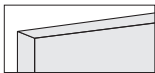

WOOD SELECTION



CORIAN®

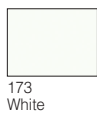

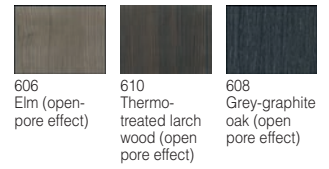

FRONT PANELS
FINISH

COLOURS / SPECIES

WOOD 3D

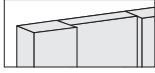

GLASS_AMX



SOLID WOOD



SOLID WOOD 3D

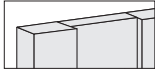

SOLID WOOD FREEHAND

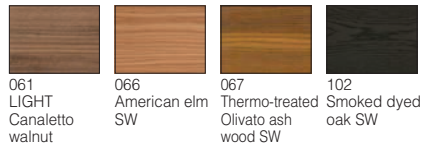
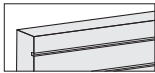

SOLID WOOD SHADES

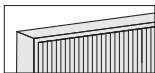

WOOD EXCLUSIVE

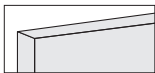

ALUMINIUM PLUS_AMX

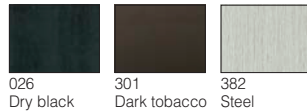

DE CASTELLI_AMX METAL

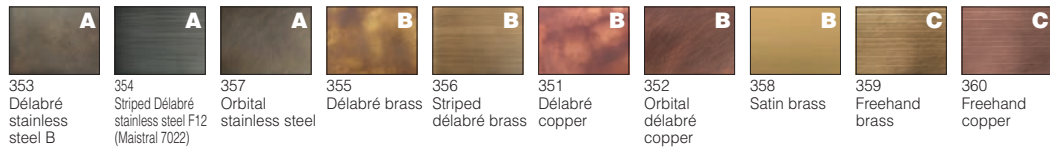

DEKTON® COMPOSITE_AMX

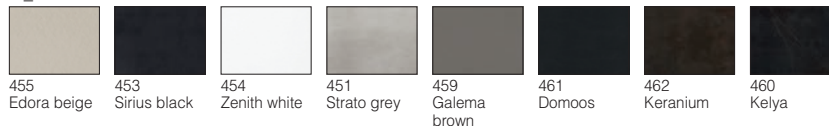

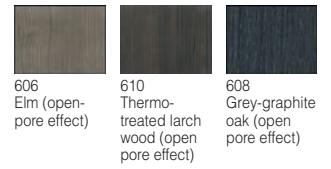

FRONT PANELS
FINISH

COLOURS / SPECIES

MDI COMPOSITE_AMX



231
Devon



232
Surrey

STONE - MARBLE - GRANITE_AMX



240
White Carrara
marble



199
Absolute black
Zimbabwe
granite



257
Quartzite
Silver



261
Emperador
Dark marble



254
Black Cosmic
granite



259
Quartzite
Calacatta



260
Grey Stone
marble



266
White Carrara
marble
Lithoverde®



265
Gris du
Marais marble
Lithoverde®



267
Pietra
d'Avola stone
Lithoverde®



270
White Carrara
marble RAW



268
Crema
d'Orcia stone
RAW



269
Pietra d'Avola
stone RAW



TOPS FINISH

COLOURS / SPECIES

WASHBASINS

CRISTALPLANT® - H 15 mm

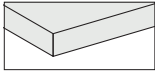

White



LASERMAT - H 20 mm

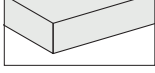

183
Kos white



178
Male white



179
Luxor beige



187
Arizona beige



184
Efeso grey



181
Londra grey



202
Antrim grey



185
Bromo grey



203
Fes blue



188
Comodoro
green



186
Orinoco
cocoa



182
Ingo black



189
Jaipur red



CORIAN® - H 20 mm

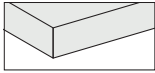

173
White



STONE - MARBLE - GRANITE - H 20 mm

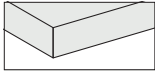

240
White Carrara
marble



250
Serena stone



199
Absolute black
Zimbabwe
granite



257
Quartzite
Silver



261
Emperador
Dark marble



254
Black Cosmic
granite



259
Quartzite
Calacatta



260
Grey Stone
marble



273
Pietra d'Avola
stone



272
Gris du
Marais marble



274
Crema
d'Orcia stone



266
White Carrara
marble
Lithoverde®



267
Pietra
d'Avola stone
Lithoverde®



265
Gris du
Marais marble
Lithoverde®

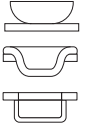

DEKTON® COMPOSITE - H 20 mm

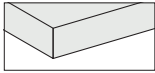

455
Edora beige



453
Sirius black



454
Zenith white



451
Strato grey



459
Galema
brown



461
Domoos



462
Keranium



460
Kelya

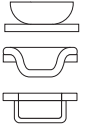

MDI COMPOSITE - H 12 mm

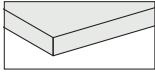

231
Devon



232
Surrey

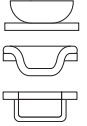

SOLID WOOD - H 23 mm

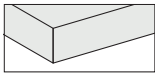

058
LIGHT Canaletto
walnut, "sawn"
effect



057
"Old" grey
pinewood



066
American elm
SW



067
Thermo-treated
Olivato ash
wood SW



102
Smoked dyed
oak SW



FREE ZONE

Design C.R.S. Boffi

Système modulaire d'éléments suspendus sans poignée.

La prise de main (et l'ouverture) des façades s'effectue grâce à la présence de la poignée-bandeau montée sur la partie supérieure du meuble.

Les caissons sont disponibles avec 3 différents systèmes d'ouverture des façades: À BATTANT / EXTRACTIBLE / COULISSANT COPLANAIRE.

Plan (1)

Plan avec chant droit aménageable avec lavabos sur plan d'appui, sur plan à encastrer, sous plan à encastrer ou affleurants moulés.

ÉPAISSEUR: 15 - 20 - 23 mm.

PROFONDEUR: 500 mm.

Caisson (2)

Réalisé en panneaux de particules de bois d'épaisseur 19 mm, hydrofuges (classe V100), à faible teneur en formaldéhyde (classe E1 / CARB P2) mélaminé avec papiers à haute densité traités avec des résines mélaminiques. Chant avant et arrière en ABS de la même couleur.

HAUTEUR CÔTÉ: 300 - 470 mm (les deux compatibles avec lavabos Boffi sur plan à encastrer / sous plan à encastrer / affleurants moulés).

PROFONDEUR CÔTÉ: 470 mm.

PROFONDEUR AVEC FAÇADE: 495 mm.

LARGEUR MODULE À BATTANT / EXTRACTIBLE: 300 - 450 - 600 - 900 - 1200 mm.

LARGEUR MODULE COULISSANT COPLANAIRE: 1200 - 1500 - 1800 - 2100 - 2400 mm.

Poignée-bandeau (obligatoire) (3).

En aluminium peint.

COULEUR: blanc / noir.

Revêtement pour poignée-bandeau (optionnel) (4)

Réalisées selon les finitions disponibles. Épaisseur variable selon la finition.

A coller ou collée à la poignée-bandeau en aluminium.

ÉPAISSEUR: max 20 mm.

Tiroirs (5)

Système LEGRABOX, avec rebords latéraux et arrière en métal peint en couleur noir mat. Fond en mélaminé noir. Façades tiroirs internes finition caisson.

Portes et façades (6)

Toutes les finitions, sauf VERRE_AMX / ALUMINIUM PLUS_AMX / DE CASTELLI_AMX A-B-C / COMPOSITE_AMX / STONE_AMX A-B-C-D-E.

Réalisées selon les finitions disponibles, épaisseur 23 mm.

Portes et façades (7)

VERRE_AMX / ALUMINIUM PLUS_AMX / DE CASTELLI_AMX A-B-C / COMPOSITE_AMX / STONE_AMX A-B-C-D-E

Réalisées avec panneau en façade selon les finitions disponibles, monté sur cadre AMX en aluminium anodisé noir. Épaisseur 18-23 mm (nominale).

Panneaux d'extrémité (8)

Réalisés selon les finitions disponibles, épaisseur 23 mm (Épaisseur 20 mm pour pierre / marbre / granite).

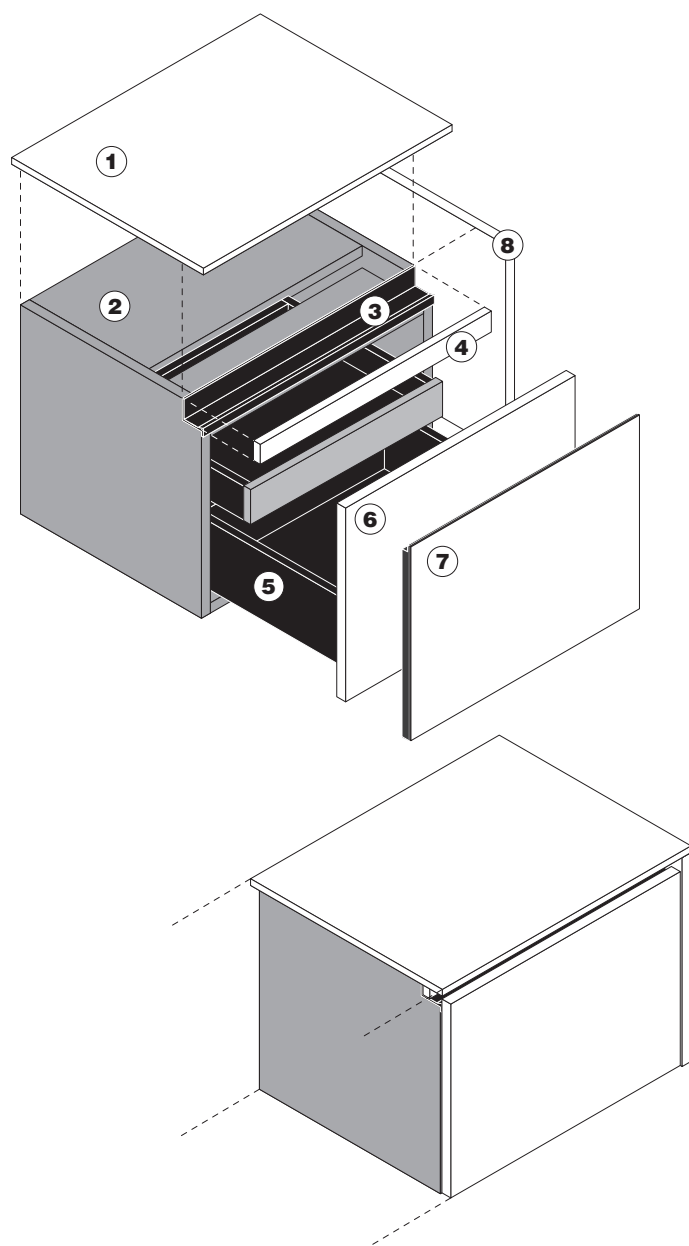

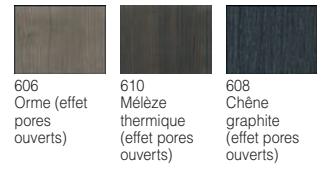

FINITION FAÇADES COULEURS / ESSENCES

EASYLAK+

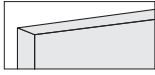

506 Blanc Cortina
507 Gris Leeds

LASERMAT

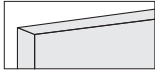

183 Blanc Kos 178 Blanc Malè 179 Beige Luxor 187 Beige Arizona 184 Gris Efeso 202 Gris Antrim 181 Gris Londra 188 Vert Comodoro 189 Rouge Jaipur 185 Gris Bromo

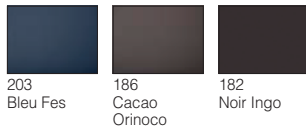

203 Bleu Fes 186 Cacao Orinoco 182 Noir Ingo

ECOLAK

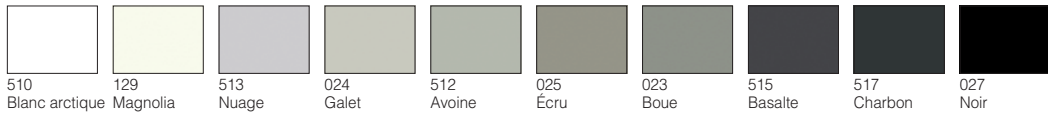
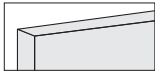

510 Blanc arctique 129 Magnolia 513 Nuage 024 Galet 512 Avoine 025 Écru 023 Boue 515 Basalte 517 Charbon 027 Noir

SILCOLAK

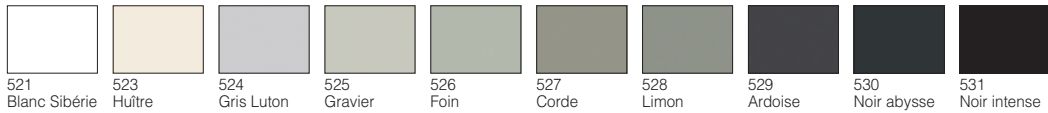

521 Blanc Sibérie 523 Hûître 524 Gris Luton 525 Gravier 526 Foin 527 Corde 528 Limon 529 Ardoise 530 Noir abysse 531 Noir intense

BOIS

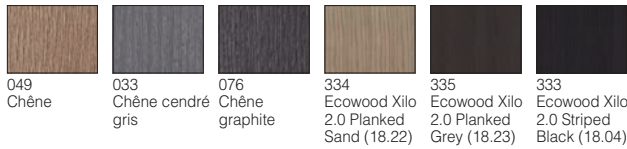
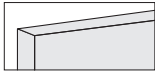

049 Chêne 033 Chêne cendré gris 076 Chêne graphite 334 Ecowood Xilo 2.0 Planked Sand (18.22) 335 Ecowood Xilo 2.0 Planked Grey (18.23) 333 Ecowood Xilo 2.0 Striped Black (18.04)

POLYESTER

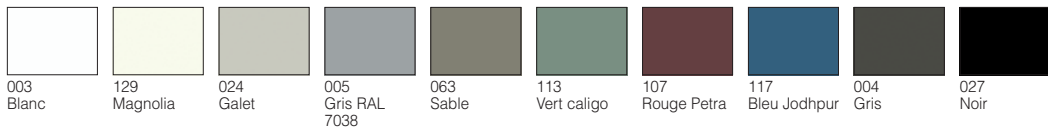
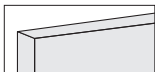

003 Blanc 129 Magnolia 024 Galet 005 Gris RAL 7038 063 Sable 113 Vert caligo 107 Rouge Petra 117 Bleu Jodhpur 004 Gris 027 Noir

METALS

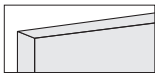

198 Blanc 934 Aluminium 197 Zinc+ 195 Laiton Vintage 196 Cuivre+ 192 Titane 191 Plomb

BOIS SELECTION



337 Orme Américain 048 Cœur de noyer 093 Noyer "canaletto" U.S. 101 Chêne fumé

CORIAN®



173 Blanc

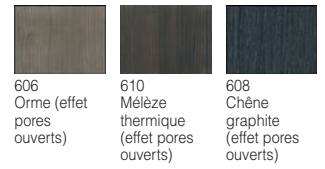

FINITION FAÇADES COULEURS / ESSENCES

BOIS 3D

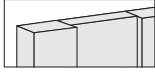

VERRE_AMX

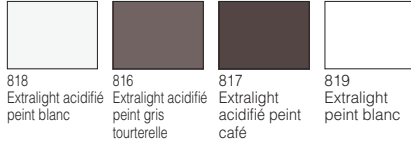

BOIS MASSIF

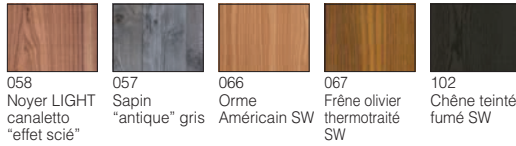

BOIS MASSIF 3D

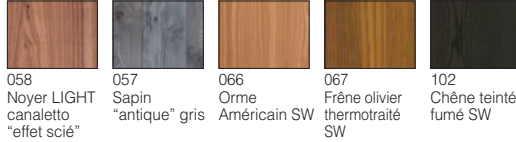
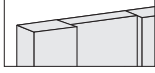

BOIS MASSIF FREEHAND

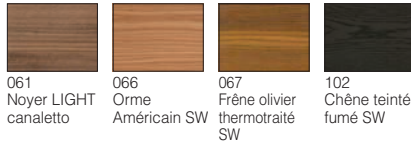
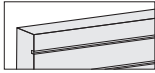

BOIS MASSIF SHADES

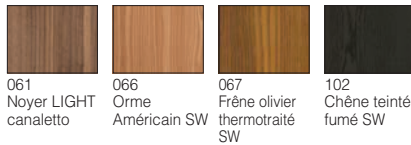
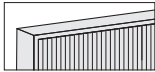

BOIS EXCLUSIVE

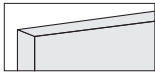

ALUMINIUM PLUS_AMX

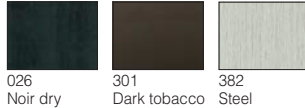

MÉTAUX DE CASTELLI_AMX

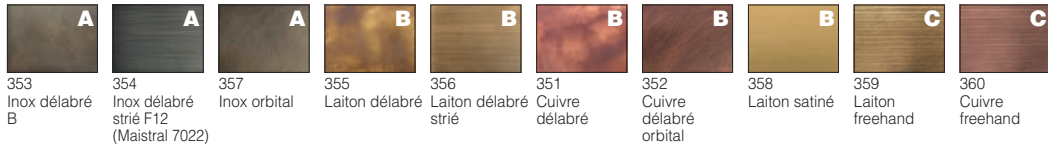

COMPOSITE DEKTON@_AMX





606
Orme (effet
pores
ouverts)

610
Mélèze
thermique
(effet pores
ouverts)

608
Chêne
graphite
(effet pores
ouverts)

FINITION FAÇADES COULEURS / ESSENCES

COMPOSITE MDI_AMX



231
Devon



232
Surrey

PIERRE - MARBRE - GRANITE_AMX



A
240
Marbre blanc
Carrara



B
199
Granite
Noir Absolu
Zimbabwe



C
257
Quartzite
Silver



D
261
Marbre
Emperador
Dark



D
254
Granite Black
Cosmic



E
259
Quartzite
Calacatta



E
260
Marbre Grey
Stone



E
266
Marbre blanc
Carrara
Lithoverde®



E
265
Marbre Gris
du Marais
Lithoverde®



E
267
Pietra d'Avola
Lithoverde®



E
270
Marbre Blanc
Carrara RAW



E
268
Pierre Crema
d'Orcia RAW



E
269
Pietra d'Avola
RAW



SUR PLAN
d'appui



SUR PLAN à
encastrer



SOUS PLAN
à encastrer



AFFLEURANT
moulé

FINITION PLANS COULEURS / ESSENCES

LAVABOS

CRISTALPLANT® - H 15 mm

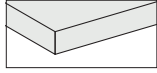

Blanc



LASERMAT - H 20 mm

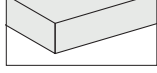

183
Blanc Kos



178
Blanc Malè



179
Beige Luxor



187
Beige Arizona



184
Gris Efeso



181
Gris Londra



202
Gris Antrim



185
Gris Bromo



203
Bleu Fes



188
Vert
Comodoro



186
Cacao
Orinoco



182
Noir Ingo



189
Rouge Jaipur



CORIAN® - H 20 mm

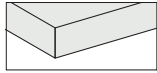

173
Blanc



PIERRE - MARBRE - GRANITE - H 20 mm

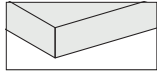

240
Marbre blanc
Carrara



250
Pierre Serena



199
Granite
Noir Absolu
Zimbabwe



257
Quartzite
Silver



261
Marbre
Emperador
Dark



254
Granite Black
Cosmic



259
Quartzite
Calacatta



260
Marbre Grey
Stone



273
Pietra d'Avola



272
Marbre Gris
du Marais



274
Pierre Crema
d'Orcia.



266
Marbre blanc
Carrara
Lithoverde®



267
Pietra d'Avola
Lithoverde®



265
Marbre Gris
du Marais
Lithoverde®



COMPOSITE DEKTON® - H 20 mm

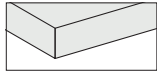

455
Beige Edora



453
Noir Sirius



454
Blanc Zenith



451
Gris Strato



459
Marron
Galema



461
Domoos



462
Keranium



460
Kelya

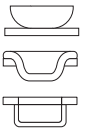

COMPOSITE MDI - H 12 mm

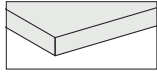

231
Devon



232
Surrey

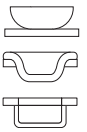

BOIS MASSIF - H 23 mm

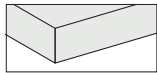

058
Noyer LIGHT
canaletto
"effet scié"



057
Sapin
"antique" gris



066
Orme
Américain SW



067
Frêne olivier
thermotraité
SW



102
Chêne teinté
fumé SW



FREE ZONE

Design C.R.S. Boffi

Anbausystem mit Hänge-Schränkelementen ohne Griffe.
Die Fronten lassen sich mithilfe der Griffleiste auf Oberkante des Schrankes öffnen.
Die Schrankelemente sind MIT TÜR / MIT FRONTAUSZUG oder MIT KOMPLANARER SCHIEBETÜR erhältlich.

Waschtischplatte (1)

Rechteckige Waschtischplatte für Aufsatz-, Einbau- von oben, Unterbau-oder flächenbündiges formgepresstes Waschbecken.

STÄRKE: 15 - 20 - 23 mm.

TIEFE: 500 mm

Schrank (2)

Aus Spanplatten, Stärke 19 mm, wasserabweisend (Klasse V100), mit niedrigem Formaldehydgehalt (Klasse E1/CARB P2) mit Melaminharzbeschichtung mit hoher Dichte. Vordere und rückseitige Kante aus ABS in Ausführung.

SEITENTEIL HÖHE: 300 - 470 mm (beide sind kompatibel mit Einbaubecken von oben / Unterbaubecken / flächenbündigen formgepressten Waschbecken Boffi).

SEITENTEIL TIEFE: 470 mm.

TIEFE MIT FRONTPANEEL: 495 mm.

BREITE DES ELEMENTS MIT TÜR / FRONTAUSZUG: 300 - 450 - 600 - 900 - 1200 mm.

BREITE DES ELEMENTS MIT KOMPLANARER SCHIEBETÜR: 1200 - 1500 - 1800 - 2100 - 2400 mm.

Griffleiste (zwingend erforderlich) (3)

Aus Aluminium lackiert.

FARBE: weiß / schwarz.

Verkleidung für Griffleiste (optional) (4)

In Ausführung. Stärke abhängig vor Ausführung.

Zu verkleben oder verklebt auf Griffleiste in Aluminium.

STÄRKE: max. 20 mm.

Schubladen (5)

System LEGRABOX mit seitlichen und rückseitigen Blenden aus mattschwarz lackiertem Metall. Boden schwarze Melaminbeschichtung. Frontpaneel der Innenschubladen in Ausführung des Schrankelements.

Türen und Frontpaneele (6)

Alle Ausführungen mit Ausnahme von GLAS_AMX / ALUMINIUM PLUS_AMX / DE CASTELLI_AMX A-B-C / AGGLOMERAT_AMX / STONE_AMX A-B-C-D-E.

In Ausführung, Stärke 23 mm.

Türen und Frontpaneele (7)

GLAS_AMX / ALUMINIUM PLUS_AMX / DE CASTELLI_AMX A-B-C / AGGLOMERAT_AMX / STONE_AMX A-B-C-D-E

Die Frontpaneele in Ausführung wird auf Rahmen AMX aus eloxiertem Aluminium schwarz montiert. Stärke 18÷23 mm (Nennstärke).

Abschlusspaneele (8)

In Ausführung, Stärke 23 mm (Stärke 20 mm für Stein / Marmor / Granit).

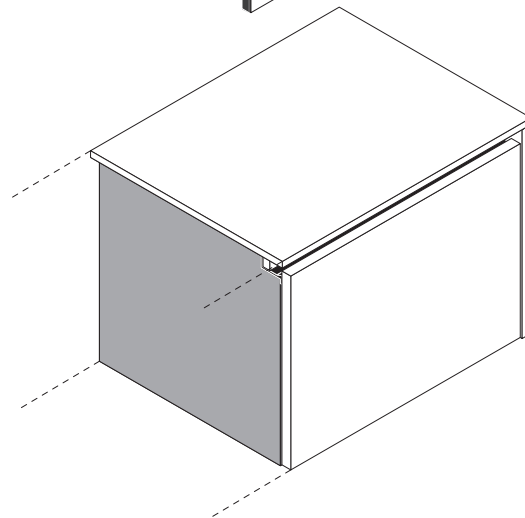
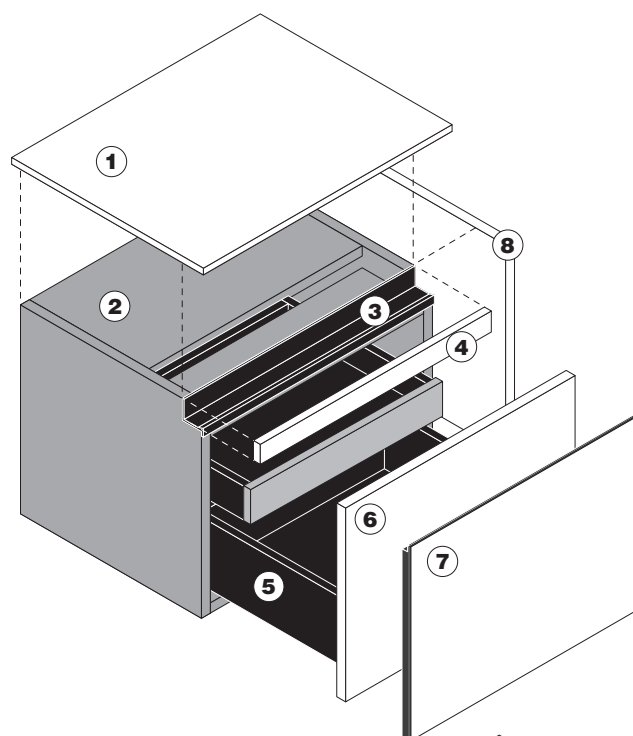

FREE ZONE

ERHÄLTICHE AUSFÜHRUNGEN - ELEMENTE

MELAMINBESCHICHTETES
SCHRANKELEMENT



606
Ulme (Effekt
offenporig)

610
Thermoholz
Lärche (Effekt
offenporig)

608
Eiche
grafitgrau
(Effekt
offenporig)

AUSFÜHRUNG
FRONTEN

FARBEN / HOLZARTEN

EASYLAK+

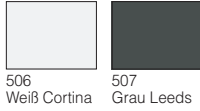

506
Weiß Cortina

507
Grau Leeds

LASERMAT

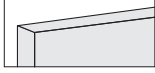

183
Weiß Kos

178
Weiß Malè

179
Beige Luxor

187
Beige Arizona

184
Grau Efeso

202
Grau Antrim

181
Grau Londra

188
Grün
Comodoro

189
Rot Jaipur

185
Grau Bromo

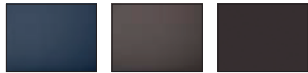

203
Blue Fes

186
Kakao
Orinoco

182
Schwarz Ingo

ECOLAK

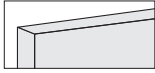

510
Arktischweiß

129
Magnolie

513
Wolkenfarben

024
Kieselgrau

512
Haferfarben

025
Ekrü

023
Lehm Braun

515
Basaltgrau

517
Kohlenschwarz

027
Schwarz

SILCOLAK

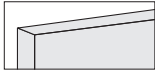

521
Weiß Sibirien

523
Perlweiß

524
Grau Luton

525
Grau Schotter

526
Heu

527
Naturfarben

528
Schlamm

529
Ardoise

530
Völlig schwarz

531
Tiefschwarz

HOLZ

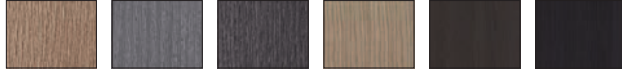

049
Eiche

033
Eiche
Aschgrau

076
Eiche
Grafitgrau

334
Ecowood Xilo
2.0 Planked
Sand (18.22)

335
Ecowood Xilo
2.0 Planked
Grey (18.23)

333
Ecowood Xilo
2.0 Striped
Black (18.04)

POLYESTER

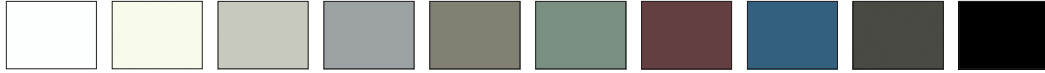
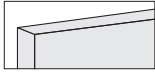

003
Weiß

129
Magnolie

024
Kieselgrau

005
Grau RAL
7038

063
Sandfarben

113
Grün caligo

107
Rot Petra

117
Blue Jodhpur

004
Grau

027
Schwarz

METALS

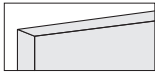

198
Weiß

934
Aluminium

197
Zink+

195
Messing
Vintage

196
Kupfer+

192
Titan

191
Blei

HOLZ SELECTION

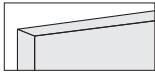

337
Amerikanische
Ulme

048
Kern-
Nussbaum

093
Nussbaum
Canaletto
U.S.

101
Räuchereiche

CORIAN®

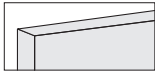

173
Weiß

FREE ZONE

ERHÄLTICHE AUSFÜHRUNGEN - ELEMENTE

MELAMINBESCHICHTETES
SCHRANKELEMENT



606
Ulme (Effect
offenporig)

610
Thermoholz
Lärche (Effect
offenporig)

608
Eiche
grafitgrau
(Effect
offenporig)

AUSFÜHRUNG

FRONTEN

FARBEN / HOLZARTEN

HOLZ 3D

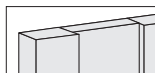

049
Eiche



033
Eiche
Aschgrau



076
Eiche
Grafitgrau



337
Amerikanische
Ulme



048
Kern-
Nussbaum



334
Ecowood Xilo
2.0 Planked
Sand (18.22)



335
Ecowood Xilo
2.0 Planked
Grey (18.23)



333
Ecowood Xilo
2.0 Striped
Black (18.04)



093
Nussbaum
Canaletto
U.S.



101
Räumereiche

GLAS_AMX



818
Geätzt Extralight
lackiert Weiß



816
Geätzt Extralight
lackiert
Taubengrau



817
Geätzt
Extralight
lackiert Kaffee



819
Extralight
lackiert Weiß

MASSIVHOLZ



058
Nussbaum
LIGHT Canaletto
Sägeschnitt



057
„Antikes“
Tannenholz
grau



066
Amerikanische
Ulme SW



067
Thermo-
Olivesche SW



102
Räumereiche
gebeizt SW

MASSIVHOLZ 3D

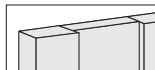

058
Nussbaum
LIGHT Canaletto
Sägeschnitt



057
„Antikes“
Tannenholz
grau



066
Amerikanische
Ulme SW



067
Thermo-
Olivesche SW



102
Räumereiche
gebeizt SW

MASSIVHOLZ FREEHAND

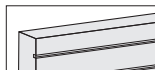

061
Nussbaum
LIGHT
Canaletto



066
Amerikanische
Ulme SW



067
Thermo-
Olivesche SW



102
Räumereiche
gebeizt SW

MASSIVHOLZ SHADES

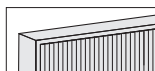

061
Nussbaum
LIGHT
Canaletto



066
Amerikanische
Ulme SW



067
Thermo-
Olivesche SW



102
Räumereiche
gebeizt SW

HOLZ EXCLUSIVE



077
Abonos fossil
oak

ALUMINIUM PLUS_AMX



026
Schwarz dry



301
Dark tobacco



382
Steel

METALL DE CASTELLI_AMX



353
Edelstahl
délabré B



354
Edelstahl délabré
gestreift F12
(Maistral 7022)



357
orbitaler/
kreisender
Edelstahl



355
Messing
délabré



356
Messing
délabré
gestreift



351
Kupfer
délabré



352
Kupfer
délabré
Orbital



358
Messing
satiniert



359
Messing
freehand



360
Kupfer
freehand

AGGLOMERAT DEKTON®_AMX



455
Beige Edora



453
Schwarz
Sirius



454
Weiß Zenith



451
Grau Strato



459
Braun Galema



461
Domoos



462
Keranium



460
Kelya

FREE ZONE

ERHÄLTICHE AUSFÜHRUNGEN - ELEMENTE

MELAMINBESCHICHTETES
SCHRANKELEMENT



606
Ulme (Effekt
offenporig)



610
Thermoholz
Lärche (Effekt
offenporig)



608
Eiche
grafitgrau
(Effekt
offenporig)

AUSFÜHRUNG

FRONTEN

FARBEN / HOLZARTEN

AGGLOMERAT MDI_AMX



231
Devon



232
Surrey

STEIN - MARMOR - GRANIT_AMX



240
Carrara-
Marmor weiß



199
Granit
Tiefschwarz
Zimbabwe



257
Quartzit Silver



261
Marmor
Emperador
Dark



254
Granit Black
Cosmic



259
Quartzit
Calacatta



260
Marmor Grey
Stone



266
Marmor
weiß Carrara
Lithoverde®



265
Marmor Gris
du Marais
Lithoverde®



267
Stein Pietra
D'Avola
Lithoverde®



270
Marmor
Carrara weiß
RAW



268
Stein Crema
d'Orcia RAW



269
Stein Pietra
D'Avola RAW

FREE ZONE

ERHÄLTICHE AUSFÜHRUNGEN - WASCHTISCHPLATTEN

WASCHBECKENARTEN



AUFSATZBECKEN



EINBAUBECKEN
von oben



UNTERBAUBECKEN



FLÄCHENBÜNDIG
formgepresst

AUSFÜHRUNG

WASCHTISCHPLATTEN FARBEN / HOLZARTEN

WASCHBECKEN

CRISTALPLANT® - H 15 mm

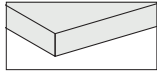

Weiß

LASERMAT - H 20 mm

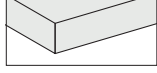

183
Weiß Kos



178
Weiß Malè



179
Beige Luxor



187
Beige Arizona



184
Grau Efeso



181
Grau Londra



202
Grau Antrim



185
Grau Bromo



203
Blue Fes



188
Grün
Comodoro



186
Kakao
Orinoco



182
Schwarz Ingo



189
Rot Jaipur

CORIAN® - H 20 mm

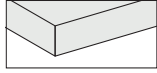

173
Weiß

STEIN - MARMOR - GRANIT - H 20 mm

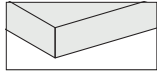

240
Carrara-
Marmor weiß



250
Stein Serena



199
Granit
Tielschwarz
Zimbabwe



257
Quartzit Silver



261
Marmor
Emperador
Dark



254
Granit Black
Cosmic



259
Quartzit
Calacatta



260
Marmor Grey
Stone



273
Stein Pietra
D'Avola



272
Marmor Gris
du Marais



274
Stein Crema
d'Orcia.



266
Marmor
weiß Carrara
Lithoverde®



267
Stein Pietra
D'Avola
Lithoverde®



265
Marmor Gris
du Marais
Lithoverde®

AGGLOMERAT DEKTON® - H 20 mm

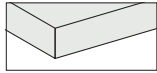

455
Beige Edora



453
Schwarz
Sirius



454
Weiß Zenith



451
Grau Strato



459
Braun Galema



461
Domoos



462
Keranium



460
Kelya

AGGLOMERAT MDI - H 12 mm

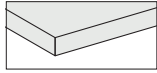

231
Devon



232
Surrey

MASSIVHOLZ - H 23 mm

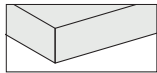

058
Nussbaum
LIGHT Canaletto
Sägeschnitt



057
„Antikes“
Tannenholz
grau



066
Amerikanische
Ulme SW



067
Thermo-
Olivesche SW



102
Räuchereiche
gebeizt SW

FREE ZONE

Design C.R.S. Boffi

Sistema modular de muebles contenedores suspendidos sin tirador.
La empuñadura (y la apertura) de los frentes se produce gracias a la presencia del perfil tirador montado en la parte superior del mueble.
Los muebles contenedores están disponibles con 3 sistemas diferentes de apertura de los frentes: BATIENTE / EXTRAÍBLE / CORREDERO COPLANARIO.

Encimera (1)

Encimera en ángulo recto que se puede equipar con lavabos sobre encimera apoyados, sobre encimera empotrados, bajo encimera empotrados y enrasados a la encimera moldeados.
GROSOR: 15 - 20 - 23 mm
PROFUNDIDAD: 500 mm.

Contenedor (2)

Realizado con paneles de partículas de madera de 19 mm. de grosor hidrófugos (clase V100), con bajo contenido de formaldehído (clase E1 / CARB P2) madera ennoblecida con papeles de alto gramaje tratados con resinas de melamina. Borde delantero y trasero de ABS del mismo color.
ALTURA COSTADO: 300 - 470 mm (ambas compatibles con lavabos Boffi sobre encimera empotrados / bajo encimera empotrados / enrasados a la encimera moldeados).
PROFUNDIDAD COSTADO: 470 mm.
PROFUNDIDAD CON FRENTE: 495 mm.
ANCHURA MÓDULO BATIENTE / EXTRAÍBLE: 300 - 450 - 600 - 900 - 1200 mm.
ANCHURA MÓDULO CORREDERO COPLANARIO: 1200 - 1500 - 1800 - 2100 - 2400 mm.

Perfil tirador (obligatorio) (3)

De aluminio pintado.
COLOR: blanco / negro.

Revestimiento para perfil tirador (optional) (4)

Realizado en acabado. Grosor variable dependiendo del acabado.
A encolar o encolada al perfil tirador de aluminio.
GROSOR: máx 20 mm.

Cajones (5)

Sistema LEGRABOX, con laterales y trasera de metal pintado en color negro mate. Fondo de madera ennoblecida negra. Frente cajones internos en acabado mueble contenedor.

Puertas y frentes (6)

Todos los acabados excepto VIDRIO_AMX / ALUMINIO PLUS_AMX / DE CASTELLI_AMX A-B-C / COMPUESTO_AMX / STONE_AMX A-B-C-D-E.
Realizadas en acabado, grosor 23 mm.

Puertas y frentes (7)

VIDRIO_AMX / ALUMINIO PLUS_AMX / DE CASTELLI_AMX A-B-C / COMPUESTO_AMX / STONE_AMX A-B-C-D-E
Realizadas con panel frontal en acabado montado en marco AMX de aluminio anodizado negro. Grosor 18÷23 mm (nominal).

Paneles terminales (8)

Realizados en acabado, grosor 23 mm (Grosor 20 mm para piedra / mármol / granito).

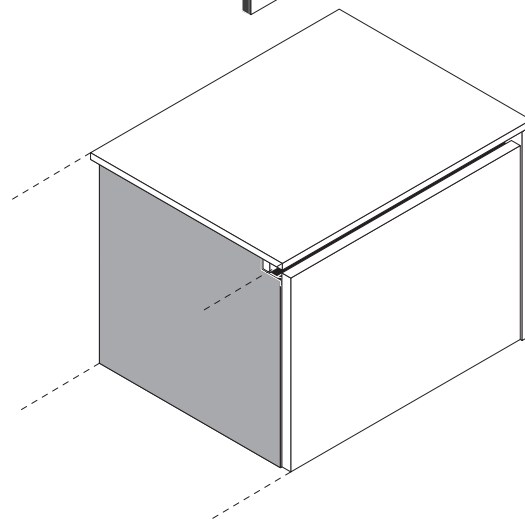
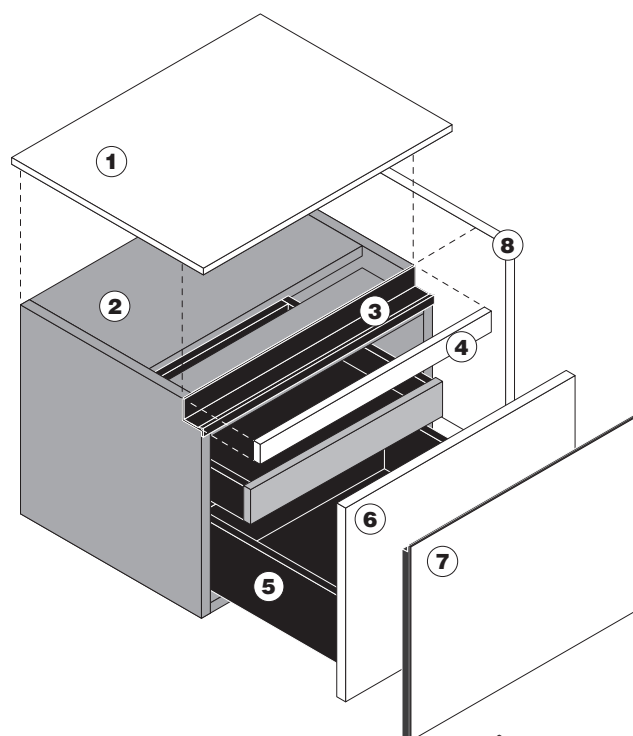

FREE ZONE

ACABADOS REALIZABLES - MUEBLES

MUEBLE
CONTENEDOR
ENNOBLECIDO.



606
Olmo (efecto
poro abierto)



610
Alerce
térmico
(efecto poro
abierto)



608
Roble grafito
(efecto poro
abierto)

ACABADO
FRENTES

COLORES / MADERAS

EASYLAK+



506
Blanco
Cortina



507
Gris Leeds

LASERMAT

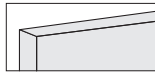

183
Blanco Kos



178
Blanco Malè



179
Beige Luxor



187
Beige Arizona



184
Gris Efeso



202
Gris Antrim



181
Gris Londra



188
Verde
Comodoro



189
Rojo Jaipur



185
Gris Bromo



203
Azul Fes



186
Cacao
Orinoco



182
Negro Ingo

ECOLAK



510
Blanco ártico



129
Magnolia



513
Nube



024
Guijarro



512
Avena



025
Crudo



023
Fango



515
Basalto



517
Carbón



027
Negro

SILCOLAK

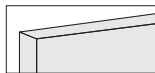

521
Blanco
Siberia



523
Ostra



524
Gris Luton



525
Grava



526
Heno



527
Cuerda



528
Limo



529
Pizzarra



530
Negro Abismo



531
Negro Intenso

MADERA

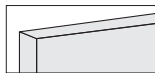

049
Roble



033
Roble ceniza



076
Roble grafito



334
Ecowood Xilo
2.0 Planked
Sand (18.22)



335
Ecowood Xilo
2.0 Planked
Grey (18.23)



333
Ecowood Xilo
2.0 Striped
Black (18.04)

POLIÉSTER



003
Blanco



129
Magnolia



024
Guijarro



005
Gris RAL
7038



063
Arena



113
Verde caligo



107
Rojo Petra



117
Azul Jodhpur



004
Gris



027
Negro

METALS

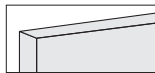

198
Blanco



934
Aluminium



197
Zink+



195
Latón Vintage



196
Cobre+



192
Titanio



191
Plomo

MADERA SELECTION



337
Olmo
americano



048
Alma de
nogal



093
Nogal canaletto
(americano)
U.S.



101
Roble
ahumado

CORIAN®



173
Blanco

FREE ZONE

ACABADOS REALIZABLES - MUEBLES

MUEBLE
CONTENEDOR
ENNOBLECIDO.



606
Olmo (efecto
poro abierto)



610
Alerce
térmico
(efecto poro
abierto)



608
Roble grafito
(efecto poro
abierto)

ACABADO
FRENTES

COLORES / MADERAS

MADERA 3D

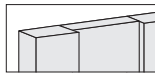

049
Roble



033
Roble ceniza



076
Roble grafito



337
Olmo
americano



048
Alma de
nogal



334
Ecowood Xilo
2.0 Planked
Sand (18.22)



335
Ecowood Xilo
2.0 Planked
Grey (18.23)



333
Ecowood Xilo
2.0 Striped
Black (18.04)



093
Nogal canaletto
(americano)
U.S.



101
Roble
ahumado

VIDRIO_AMX



818
Extralight al
ácido pintado
blanco



816
Extralight al
ácido pintado
gris ceniciento



817
Extralight al
ácido lacado
café



819
Extralight
pintado
blanco

MADERA MACIZA



058
Nogal LIGHT
canaletto
"corte sierra"



057
Abeto
"antiguo" gris



066
Olmo
americano
SW



067
Fresno Olivato
termotratado
SW



102
Roble teñido
ahumado SW

MADERA MACIZA 3D

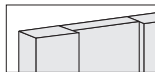

058
Nogal LIGHT
canaletto
"corte sierra"



057
Abeto
"antiguo" gris



066
Olmo
americano
SW



067
Fresno Olivato
termotratado
SW



102
Roble teñido
ahumado SW

MADERA MACIZA FREEHAND

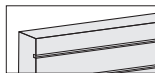

061
Nogal LIGHT
canaletto



066
Olmo
americano
SW



067
Fresno Olivato
termotratado
SW



102
Roble teñido
ahumado SW

MADERA MACIZA SHADES

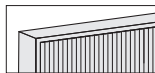

061
Nogal LIGHT
canaletto



066
Olmo
americano
SW



067
Fresno Olivato
termotratado
SW



102
Roble teñido
ahumado SW

MADERA EXCLUSIVE

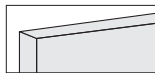

077
Abonos fossil
oak

ALUMINIO PLUS_AMX

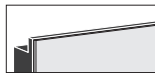

026
Negro dry



301
Dark tobacco



382
Steel

METAL DECASTELLI_AMX



353
Acero
inoxidable
délabré B



354
Inox délabré
estriado F12
(Maistral 7022)



357
Acero
inoxidable
orbital



355
Latón délabré



356
Latón délabré
estriado



351
Cobre délabré



352
Cobre délabré
orbital



358
Latón
satinado



359
Latón
freehand



360
Cobre
freehand

COMPUESTO DEKTON@_AMX



455
Beige Edora



453
Negro Sirius



454
Blanco Zenith



451
Gris Strato



459
Marrón
Galema



461
Domoos



462
Keranium



460
Kelya

FREE ZONE

ACABADOS REALIZABLES - MUEBLES

MUEBLE
CONTENEDOR
ENNOBLECIDO.



606
Olmo (efecto
poro abierto)



610
Alerce
térmico
(efecto poro
abierto)



608
Roble grafito
(efecto poro
abierto)

ACABADO
FRENTEROS

COLORES / MADERAS

COMPUESTO MDI_AMX



231
Devon



232
Surrey

PIEDRA - MÁRMOL - GRANITO_AMX



240
Mármol
blanco
Carrara



199
Granito Negro
Absoluto
Zimbabwe



257
Cuarcita Silver



261
Mármol
Emperador
Dark



254
Granito Black
Cosmic



259
Cuarcita
Calacatta



260
Mármol Grey
Stone



266
Mármol blanco
Carrara
Lithoverde®



265
Mármol Gris
du Marais
Lithoverde®



267
Pietra d'Avola
Lithoverde®



270
Mármol
Blanco
Carrara RAW



268
Piedra Crema
d'Orcia RAW



269
Pietra d'Avola
RAW

FREE ZONE

ACABADOS REALIZABLES - ENCIMERAS

TIPOS LAVABOS



SOBRE
ENCIMERA
apoyado



SOBRE
ENCIMERA
empotrado



BAJO
ENCIMERA
empotrado



ENRASADO
A LA
ENCIMERA
moldeado

ACABADO
ENCIMERAS

COLORES / MADERAS

LAVABOS

CRISTALPLANT® - H 15 mm

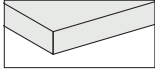

Blanco

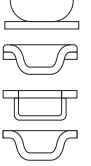

LASERMAT - H 20 mm

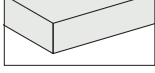

183
Blanco Kos



178
Blanco Malé



179
Beige Luxor



187
Beige Arizona



184
Gris Efeso



181
Gris Londra



202
Gris Antrim



185
Gris Bromo



203
Azul Fes



188
Verde
Comodoro



186
Cacao
Orinoco



182
Negro Ingo



189
Rojo Jaipur



CORIAN® - H 20 mm

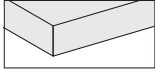

173
Blanco



PIEDRA - MÁRMOL - GRANITO - H 20 mm

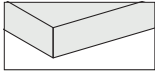

240
Mármol
blanco
Carrara



250
Piedra Serena



199
Granito Negro
Absoluto
Zimbabwe



257
Cuarcita Silver



261
Mármol
Emperador
Dark



254
Granito Black
Cosmic



259
Cuarcita
Calacatta



260
Mármol Grey
Stone



273
Pietra d'Avola



272
Mármol Gris
du Marais



274
Piedra Crema
d'Orcia.



266
Mármol blanco
Carrara
Lithoverde®



267
Pietra d'Avola
Lithoverde®



265
Mármol Gris
du Marais
Lithoverde®

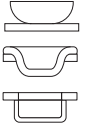

COMPUESTO DEKTON® - H 20 mm

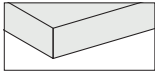

455
Beige Edora



453
Negro Sirius



454
Blanco Zenith



451
Gris Strato



459
Marrón
Galema



461
Domoos



462
Keranium



460
Kelya

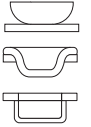

COMPUESTO MDI - H 12 mm

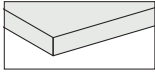

231
Devon



232
Surrey

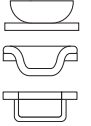

MADERA MACIZA - H 23 mm

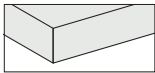

058
Nogal LIGHT
canaletto
"corte sierra"



057
Abeto
"antiguo" gris



066
Olmo
americano
SW



067
Fresno Olivato
termotratado
SW



102
Roble teñido
ahumado SW

