

TECHNICAL DATA

# ROLF BENZ 650

---



**ROLF  
BENZ**

- Seat and back made out of moulded wood
- Four leg circular tubular base metal, options:
  - Smooth steel, powder-coated, matt
    - RAL 7022 Umbra grey
    - RAL 9017 Traffic black
  - Steel high-gloss chrome
- Four leg solid wood, colorless painted, options:
  - Oak
  - Oak black pigmented
  - American walnut (against surcharge)

• Chair with upholstery on seat and back

**Seat and back made out of moulded wood**

- Four leg circular tubular base metal, options:
  - Smooth steel, powder-coated, matt
    - RAL 7022 Umbra grey
    - RAL 9017 Traffic black
  - Steel high-gloss chrome
- Four leg solid wood, colorless painted, options:
  - Oak
  - Oak black pigmented
  - American walnut (against surcharge)
- Seat and back made of polyurethane foam, built up in coordinated layers varying in height and firmness and with a bonded non-woven polyester cover
- Seat cushions quilted underneath with non-woven polyester and a polyurethane padding:

**Seat cushions fabric cover**

available in 4 colours:

- 01 grey beige
- 02 beige grey
- 03 black grey
- 04 cement grey

**Seat cushions premium imitation of polyurethane**

available in 3 colours:

- 05 grey-beige
- 06 anthracite-grey
- 07 stone grey

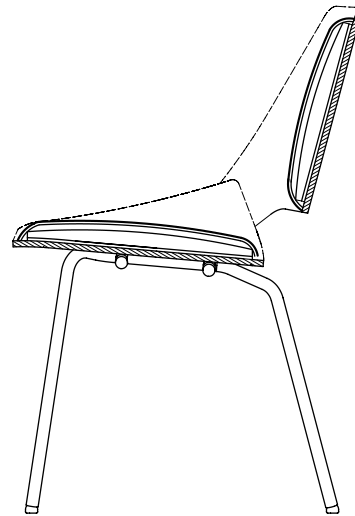

Chair four-leg metal

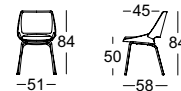

Chair four-leg wood

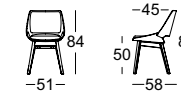

Footstool with metal leg

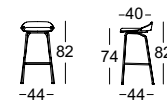

Footstool with wood leg

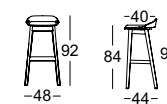
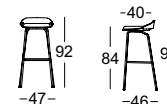
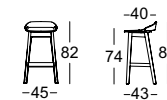

**ROLF  
BENZ**