

Technical part



// Wooden inner frame

// Sprung base with steel shafts

// **Seatcomfort „Lounge Plus“**

Seat in high-quality cold foam, built up in coordinated layers of varying height and firmness, with a polyester nonwoven cover

// **Seatcomfort „Lounge Deluxe“**

Seat made of high-quality cold foam, built up in coordinated layers, covered with a mat consisting of 20 % viscose foam and 80 % microfibres and a non-woven polyester cover

// Back pad made from polyurethane foam

// Upholstery cover glued-on non-woven polyester

// Back cover quilted with polyester fleece

// Downy-soft back cushions worked into chambers with a filling of 100 % microfibres

// Seat heights options:

› 37 cm (only available with plastic base)

› 41 cm (only available with cast aluminium base)

› 44 cm (only available with cast aluminium base)

// Cast foot metal, options:

› Aluminium, polished

› Smooth aluminium, powder-coated, matt:

• RAL 9017 Traffic black

• RAL 7022 Umbra grey

// Plastic

! Due to the way the furniture is designed, and its comfort level, some wrinkles and sitting pressure indentations are inevitable, even in top quality Rolf Benz upholstered furniture. All dimensions are approximate.



Lounge Plus

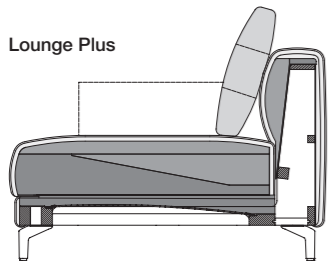

Lounge Deluxe

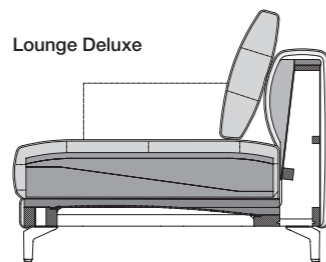

Side element narrow

Side element wide

K-SOB NUVOLA/SB 168

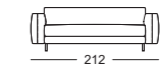

K-ASO NUVOLA/SB 105*

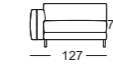
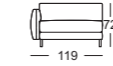

K-ASO NUVOLA/SB 126*

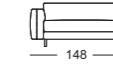
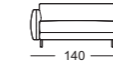

K-ASO NUVOLA/SB 147*

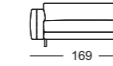
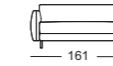

K-ASO NUVOLA/SB 168*

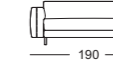
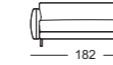

K-E-ASO NUVOLA/SB 168*

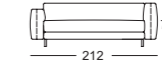
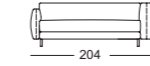

K-ASO-PSZ NUVOLA/SB 147*

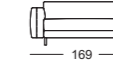
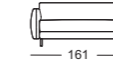

K-ASS-PSZ NUVOLA/SB 105*

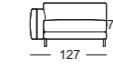
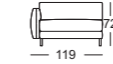

K-XL-ASO NUVOLA/SB 105*

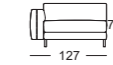
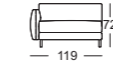

K-XL-ASO NUVOLA/SB 147*

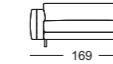
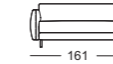

K-E-ARB NUVOLA/SB 126*

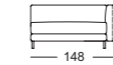

K-E-ARB NUVOLA/SB 147*

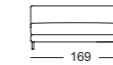

K-E-ARB NUVOLA/SB 168*



K-XL-E-ARB NUVOLA/SB 147*



K-EPT NUVOLA/SB 105*

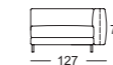

*These elements are only shown in the left version. They are also available in the right version.

	Side element narrow
K-ARB NUVOLA/SB 105	
K-ARB NUVOLA/SB 126	
K-ARB NUVOLA/SB 147	
K-ARB NUVOLA/SB 168	
K-XL-ARB NUVOLA/SB 105	
K-UE-XL-ARB NUVOLA/SB 105	
K-UE-XL-ARB NUVOLA/SB 147	

	Side element wide
-	-
-	-
-	-
-	-
-	-
-	-
-	-

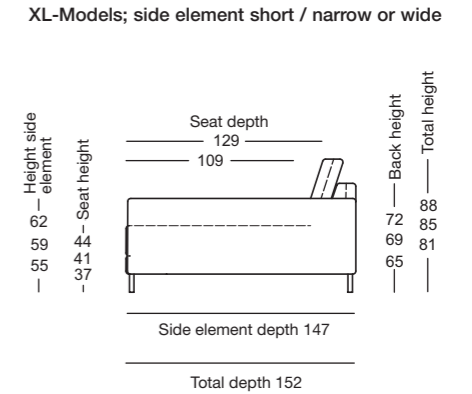
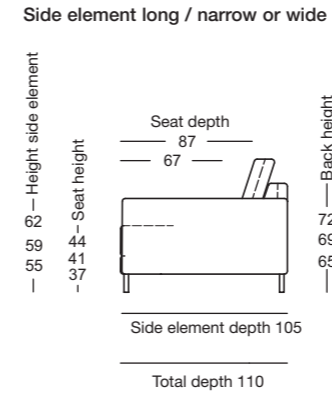

Upholstered bench element

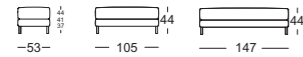

Back cushion

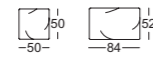

Back cushion



Back cushion low

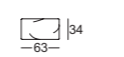

Back cushion with rol



High back cushion with rol



Adjustable high back cushion with rol



Upholstered cushion

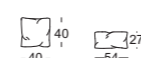

Side element short / narrow or wide

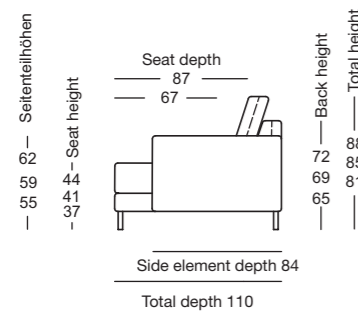

XL-Models; side element short / narrow or wide

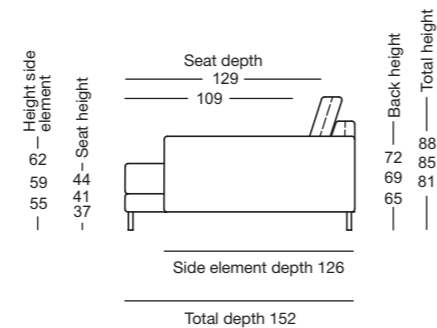

Matching



Rolf Benz 987

// Type: Storage table/interlocking table

Dimensions:
Height 35 or 38 cm: 103 x 40 cm

// Type: Shelving

Dimensions:
Höhe 55 oder 58 cm: 103 x 30 cm

// Table top:

Solid wood, clear varnish: oak, stained black oak, American walnut

// Frame:

Painted steel painted in matt:

- › RAL 7022 umbra grey or
- › RAL 9017 traffic black



Rolf Benz 8770

// Coffee table/side table

// Dimensions:

- › Height 40 cm: Ø 42 cm
- › Height 30 cm: Ø 80 or 95 cm

// Top:

- › Parsol glass grey; Optiwhite glass with painted underside: RAL 9017 traffic black, RAL 7022 umbra grey or RAL 1020 olive yellow
- › Ceramic (bonded onto clear glass) Calacatta or Emperador extra

// Frame:

Smooth steel, powder-coated, matt:

- › RAL 9017 traffic black
- › RAL 7022 umbra grey
- › RAL 1020 olive yellow

All technical specifications relevant to the furniture ranges are correct at the time of publication. Subsequent modifications are possible. Colours may differ slightly for technical printing reasons. Please see the samples in store.