



COLLECTIONS

LIGHTING



COLLECTIONS

LIGHTING



Contents

6	ABETE	Pendant
14	ANDON	Floor
26	ANNA	Table
36	AVA	Floor/Table, Pendant
48	BOMBORI	Floor, Pendant
60	CUT BACK	Wall, Pendant, Floor,
98	DROP PAPER LAMP	Floor, Pendant
112	DT LIGHT 25	Floor-to-ceiling
126	ELEMENTI	Floor/Table, Pendant
150	FIREFLY	Portable
164	GIÒ	Pendant
178	HELIUM	Floor/Table, Wall, Pendant
196	HELIUM MINI	Table, Pendant
232	L.O.P.	Pendant
242	LANTERN	Floor, Pendant
250	LANTIA	Floor/Table, Pendant
260	LINEA D'OMBRA	Floor/Table
268	LINEAR LIGHT SYSTEM	Pendant
288	MOGURA	Floor, Table, Pendant
300	NAGOYA	Floor/Table
310	NAVIGLIO	Pendant
320	NOTA	Floor, Wall
330	POET	Floor/Table, Pendant
340	TSUKI	Floor/Table



The De Padova lighting collections inspire and transform space via a variety of forms, iconic designs from the past, contemporary pieces as well as a careful selection of materials and elements that together turn light into art. This modulation becomes poetry, enhancing indoor and outdoor spaces with unique silhouettes and a captivating interplay of light and shadow. Function meets aesthetics, allowing lighting to transform into a low table, into a portable lantern that moves effortlessly from room to room. There are modular compositions that descend from the ceiling like a luminous rain, blending seamlessly with the walls to adapt to the dimensions of any space. De Padova draws on the know-how of leading Italian and international designers, expanding its lighting offerings year after year. These collections perfectly complement the brand's furniture selections, embodying the Boffi|DePadova way of living: a holistic approach to the home where light becomes a defining detail that captures the essence of each interior.

ABETE

Paolo Tilche



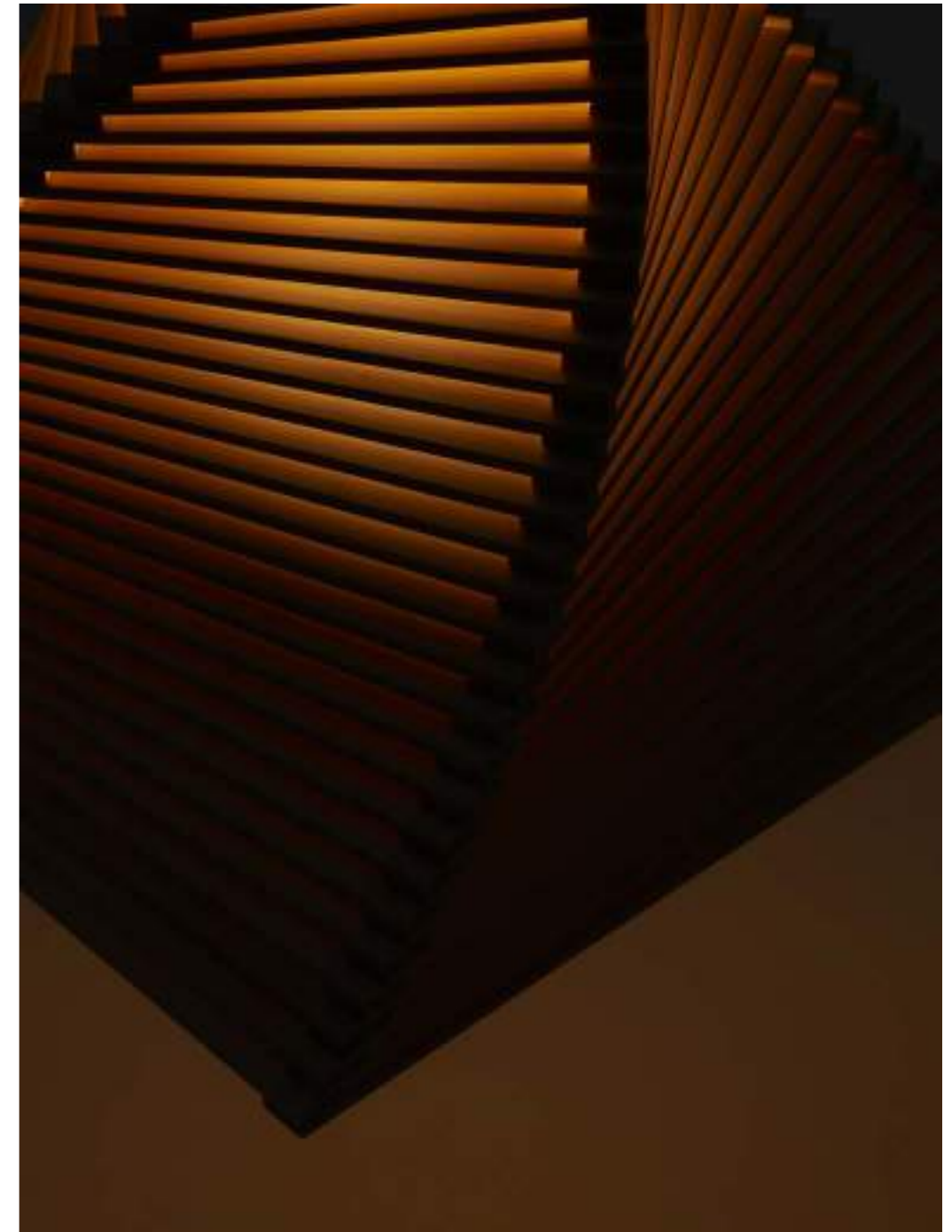







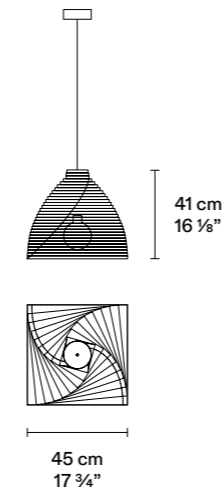

ABETE  
Paolo Tilche, 1971–2023

IT Abete è una lampada a sospensione che racchiude un minuto capolavoro di equilibri e si sviluppa su moduli quadrati in maniera decrescente. Disegnata dall'architetto Paolo Tilche, Abete è una spirale che spicca per il suo gioco di sovrapposizioni che fa convergere la luce per poi irradiarla con un movimento sottile, sinuoso.

EN Abete is a pendant lamp that encapsulates a miniature masterpiece of balance, unfolding through a series of progressively smaller square modules. Designed by architect Paolo Tilche, Abete takes the shape of a spiral distinguished by its interplay of overlapping forms, which concentrates the light before diffusing it in a subtle, sinuous motion.

Pendant lamp



<b>Materiali</b> Materials	Legno massello Solid wood
<b>Finiture</b> Finishes	Abete naturale Natural spruce
<b>Categoria</b> Category	Sospensione Pendant
<b>Specifiche tecniche</b> Technical details	EU 220÷240 V – 50/60 Hz LED E27, max 21 W
	USA 100÷120 V – 50/60 Hz LED E26, max 21 W
	   
<b>Controllo</b> Control	Dimmer non incluso nella lampada Dimmer not included on the lamp
<b>Certificazioni</b> Certifications	 

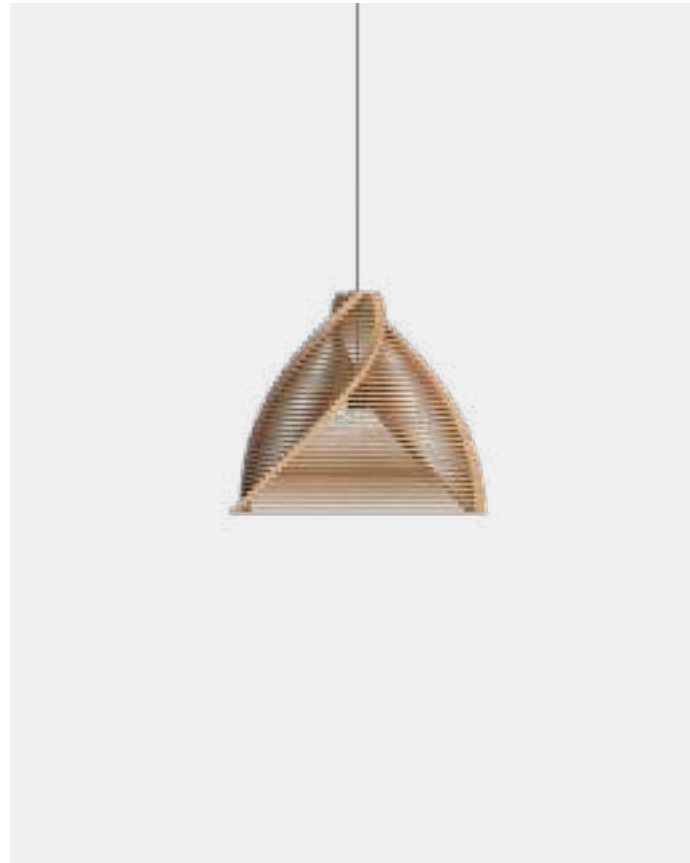

Pendant lamp

ANDON

Nendo











ANDON  
Nendo, 2022

IT La collezione Andon ribalta il concetto classico di tavolino, in cui è il top a prendere il valore funzionale dell'oggetto, trasformando la struttura in una lampada per illuminare tutto ciò che c'è intorno, incontrando così la tradizione giapponese del dormire e del sedersi per terra. Pensato per l'outdoor in versione tonda e quadrata, la pergamena di questo tavolino-lampada è assolutamente impermeabile, così come il top in pietra lavica nera smaltata o pietra pece bianca, dalla texture materica. Andon può essere anche scelto nella variante tavolino senza illuminazione, per dare dinamismo alla composizione accostando più forme, tonalità, strutture.

EN The Andon collection overturns the classic concept of coffee table, in which the tabletop is the functional value of the object, by transforming the frame into a lamp illuminating everything around it, thus converging with the Japanese tradition of sleeping and sitting on the floor. Conceived for the outdoors, in a round and square version, the parchment of this coffee-table-lamp is completely waterproof, just like the tabletop in black enamelled lava stone, or white pitchstone. Andon can also be selected as a coffee table without the lighting, and the composition's dynamism can be enhanced by matching additional shapes, shades and frames.



Square version

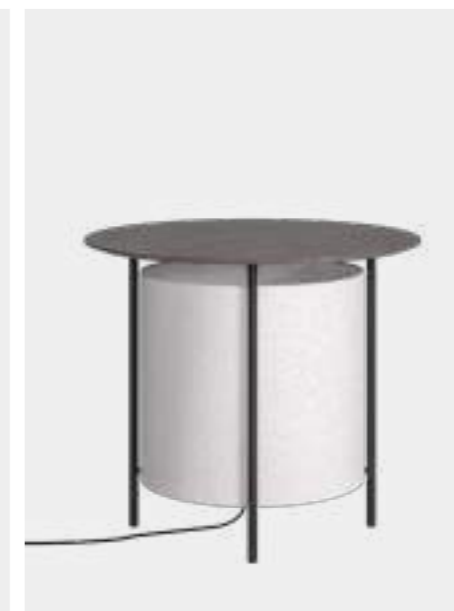

Round version

Square version

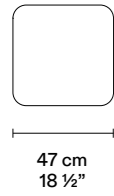
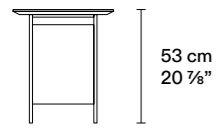

<b>Materiali</b> Materials	Acciaio inox, pergamena, pietra lavica, marmo, composito MDI Stainless steel, parchment, lava stone, Pece stone, marble, MDI composite																
<b>Categoria</b> Category	Da terra Floor																
<b>Finiture per ambienti interni</b> Finishes for indoor use	<table border="1"> <tr><td>Marmo bianco Carrara White Carrara marble</td><td></td></tr> <tr><td>Marmo Valentine Grey Valentine Grey marble</td><td></td></tr> <tr><td>Marmo Emperador Dark Emperador Dark marble</td><td></td></tr> <tr><td>Marmo Grigio Carnico Grey Carnico marble</td><td></td></tr> <tr><td>Marmo Verde Alpi Verde Alpi marble</td><td></td></tr> <tr><td>Marmo Rosso Lepanto Rosso Lepanto marble</td><td></td></tr> <tr><td>Marmo Calacatta Oro Calacatta Oro marble</td><td></td></tr> <tr><td>Marmo Grey Stone Grey Stone marble</td><td></td></tr> </table>	Marmo bianco Carrara White Carrara marble		Marmo Valentine Grey Valentine Grey marble		Marmo Emperador Dark Emperador Dark marble		Marmo Grigio Carnico Grey Carnico marble		Marmo Verde Alpi Verde Alpi marble		Marmo Rosso Lepanto Rosso Lepanto marble		Marmo Calacatta Oro Calacatta Oro marble		Marmo Grey Stone Grey Stone marble	
Marmo bianco Carrara White Carrara marble																	
Marmo Valentine Grey Valentine Grey marble																	
Marmo Emperador Dark Emperador Dark marble																	
Marmo Grigio Carnico Grey Carnico marble																	
Marmo Verde Alpi Verde Alpi marble																	
Marmo Rosso Lepanto Rosso Lepanto marble																	
Marmo Calacatta Oro Calacatta Oro marble																	
Marmo Grey Stone Grey Stone marble																	
<b>Finiture per ambienti esterni coperti</b> Finishes for sheltered outdoor use	<table border="1"> <tr><td>Pietra Bianco Pece White Pece stone</td><td></td></tr> <tr><td>Pietra Lavica Nera Smaltata Black Enamelled Lava Stone</td><td></td></tr> <tr><td>MDI Bihara MDI Bihara</td><td></td></tr> <tr><td>MDI Devon MDI Devon</td><td></td></tr> <tr><td>MDI Surrey MDI Surrey</td><td></td></tr> <tr><td>MDI Kanran MDI Kanran</td><td></td></tr> </table>	Pietra Bianco Pece White Pece stone		Pietra Lavica Nera Smaltata Black Enamelled Lava Stone		MDI Bihara MDI Bihara		MDI Devon MDI Devon		MDI Surrey MDI Surrey		MDI Kanran MDI Kanran					
Pietra Bianco Pece White Pece stone																	
Pietra Lavica Nera Smaltata Black Enamelled Lava Stone																	
MDI Bihara MDI Bihara																	
MDI Devon MDI Devon																	
MDI Surrey MDI Surrey																	
MDI Kanran MDI Kanran																	
<b>Specifiche tecniche</b> Technical details	<p>EU 220÷240 V – 50/60 Hz LED E27, max 13 W</p> <p>USA 100÷120 V – 50/60 Hz LED E26, max 13 W</p> <div style="display: flex; gap: 5px;"> <div style="border: 1px solid black; padding: 2px;">IP21</div> <div style="border: 1px solid black; padding: 2px;"></div> <div style="border: 1px solid black; padding: 2px;"></div> </div>																
<b>Controllo</b> Control	Dimmer non integrato nella lampada Dimmer not integrated on the lamp																
<b>Certificazioni</b> Certifications																	

Round version

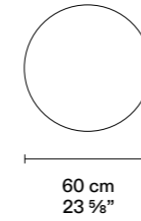
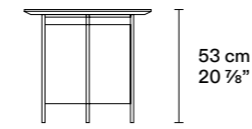

<b>Materiali</b> Materials	Acciaio inox, pergamena, pietra lavica, marmo, composito MDI Stainless steel, parchment, lava stone, Pece stone, marble, MDI composite																
<b>Categoria</b> Category	Da terra Floor																
<b>Finiture per ambienti interni</b> Finishes for indoor use	<table border="1"> <tr><td>Marmo Bianco Carrara White Carrara marble</td><td></td></tr> <tr><td>Marmo Valentine Grey Valentine Grey marble</td><td></td></tr> <tr><td>Marmo Emperador Dark Emperador Dark marble</td><td></td></tr> <tr><td>Marmo Grigio Carnico Grey Carnico marble</td><td></td></tr> <tr><td>Marmo Verde Alpi Verde Alpi marble</td><td></td></tr> <tr><td>Marmo Rosso Lepanto Rosso Lepanto marble</td><td></td></tr> <tr><td>Marmo Calacatta Oro Calacatta Oro marble</td><td></td></tr> <tr><td>Marmo Grey Stone Grey Stone marble</td><td></td></tr> </table>	Marmo Bianco Carrara White Carrara marble		Marmo Valentine Grey Valentine Grey marble		Marmo Emperador Dark Emperador Dark marble		Marmo Grigio Carnico Grey Carnico marble		Marmo Verde Alpi Verde Alpi marble		Marmo Rosso Lepanto Rosso Lepanto marble		Marmo Calacatta Oro Calacatta Oro marble		Marmo Grey Stone Grey Stone marble	
Marmo Bianco Carrara White Carrara marble																	
Marmo Valentine Grey Valentine Grey marble																	
Marmo Emperador Dark Emperador Dark marble																	
Marmo Grigio Carnico Grey Carnico marble																	
Marmo Verde Alpi Verde Alpi marble																	
Marmo Rosso Lepanto Rosso Lepanto marble																	
Marmo Calacatta Oro Calacatta Oro marble																	
Marmo Grey Stone Grey Stone marble																	
<b>Finiture per ambienti esterni coperti</b> Finishes for sheltered outdoor use	<table border="1"> <tr><td>Pietra Bianco Pece White Pece stone</td><td></td></tr> <tr><td>Pietra Lavica Nera Smaltata Black Enamelled Lava Stone</td><td></td></tr> <tr><td>MDI Bihara MDI Bihara</td><td></td></tr> <tr><td>MDI Devon MDI Devon</td><td></td></tr> <tr><td>MDI Surrey MDI Surrey</td><td></td></tr> <tr><td>MDI Kanran MDI Kanran</td><td></td></tr> </table>	Pietra Bianco Pece White Pece stone		Pietra Lavica Nera Smaltata Black Enamelled Lava Stone		MDI Bihara MDI Bihara		MDI Devon MDI Devon		MDI Surrey MDI Surrey		MDI Kanran MDI Kanran					
Pietra Bianco Pece White Pece stone																	
Pietra Lavica Nera Smaltata Black Enamelled Lava Stone																	
MDI Bihara MDI Bihara																	
MDI Devon MDI Devon																	
MDI Surrey MDI Surrey																	
MDI Kanran MDI Kanran																	
<b>Specifiche tecniche</b> Technical details	<p>EU 220÷240 V – 50/60 Hz LED E27, max 13 W</p> <p>USA 100÷120 V – 50/60 Hz LED E26, max 13 W</p> <div style="display: flex; gap: 5px;"> <div style="border: 1px solid black; padding: 2px;">IP21</div> <div style="border: 1px solid black; padding: 2px;"></div> <div style="border: 1px solid black; padding: 2px;"></div> </div>																
<b>Controllo</b> Control	Dimmer non integrato nella lampada Dimmer not integrated on the lamp																
<b>Certificazioni</b> Certifications																	

ANNA

Paolo Tilche



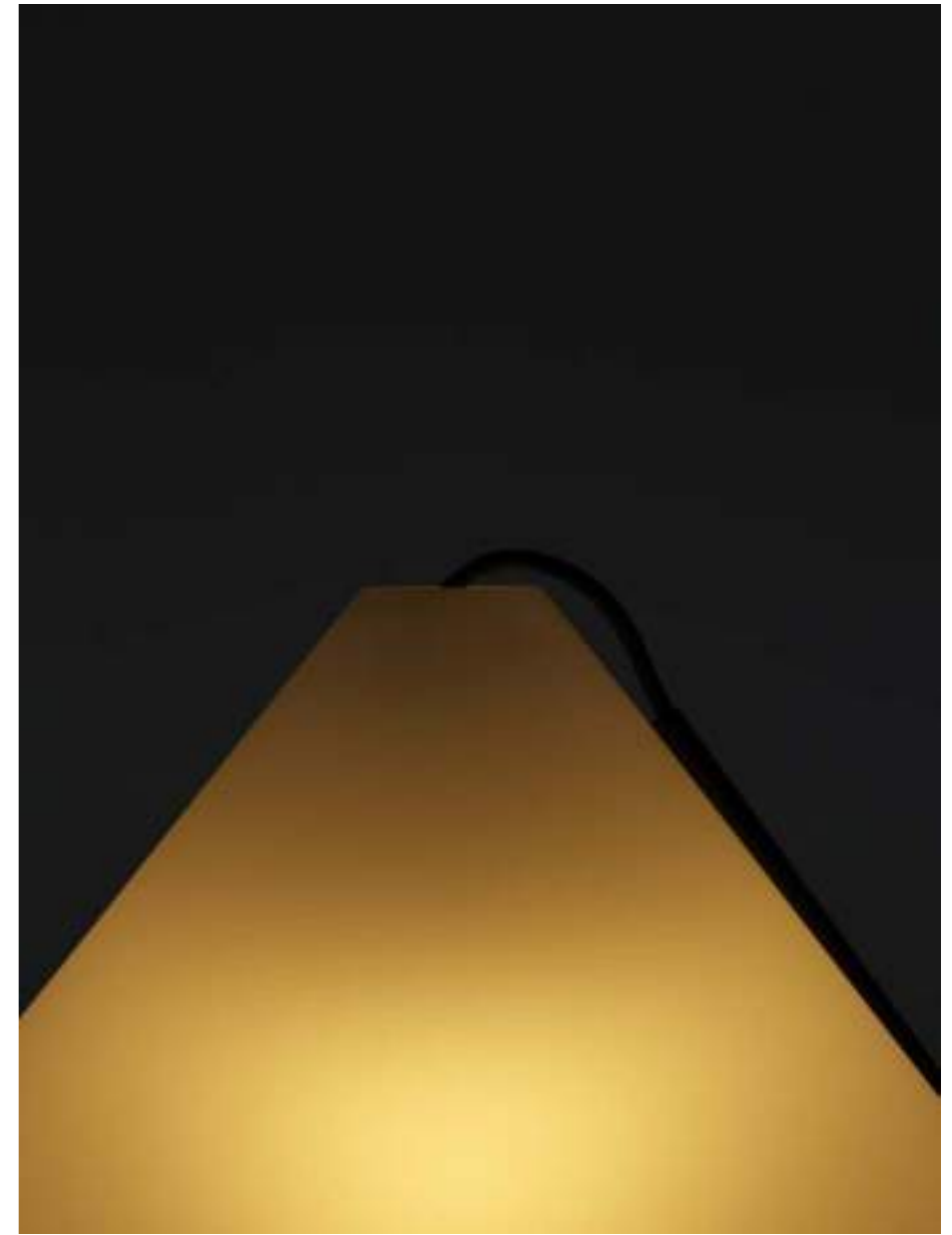





IT La lampada da tavolo Anna si riassume in un paralume conico, semplicissimo, con un unico tondino di acciaio forato per risolvere insieme base d'appoggio e passaggio del cavo. Le sue linee essenziali diffondono sia luce diretta che indiretta illuminando la superficie sottostante e incorniciando di luce le pareti, la stanza, tutto ciò che le ruota intorno.

EN The Anna table lamp is a very simple conical lampshade with a single perforated steel rod that forms the base and houses the electric cable. Its sleek lines shed both direct and indirect light by illuminating the surface below it and the walls, room and everything around it.



Black version

White version

Black version

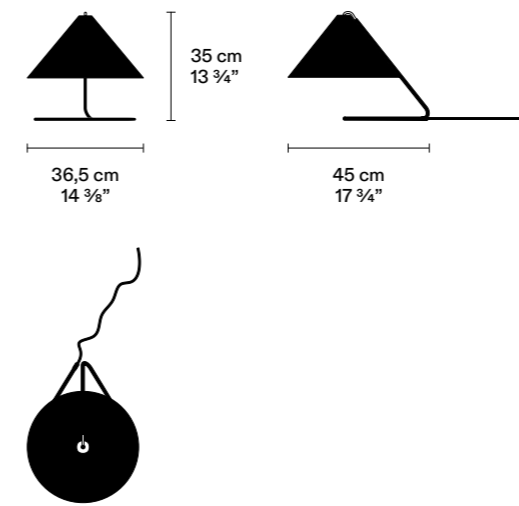

<b>Materiali</b> Materials	Metallo, policarbonato, alluminio Metal, polycarbonate, aluminium
<b>Finiture</b> Finishes	Nero opaco "soft touch" Matt black "soft touch"
<b>Categoria</b> Category	Da tavolo Table
<b>Specifiche tecniche</b> Technical details	EU 220÷240 V – 50/60 Hz LED 7 W, 2700K, CRI85  USA 100÷120 V – 50/60 Hz LED 7 W, 2700K, CRI85
<b>Controllo</b> Control	Dimmer integrato nel cavo di alimentazione Power cable with integrated dimmer
<b>Certificazioni</b> Certifications	CE

White version

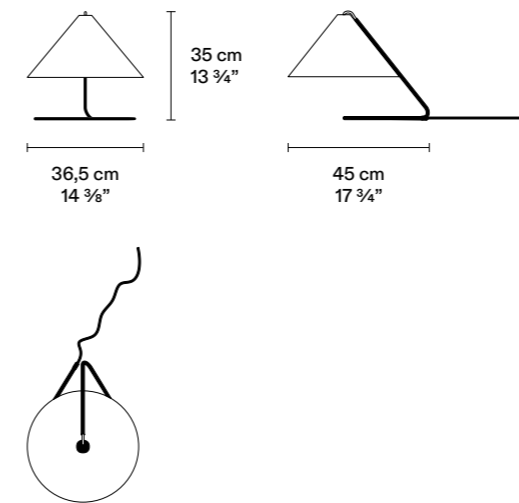

<b>Materiali</b> Materials	Metallo, policarbonato, alluminio Metal, polycarbonate, aluminium
<b>Finiture</b> Finishes	Bianco satinato "velvet touch" Satin white "velvet touch"
<b>Categoria</b> Category	Da tavolo Table
<b>Specifiche tecniche</b> Technical details	EU 220÷240V – 50/60Hz LED E27, max 10W  USA 100÷120V – 50/60Hz LED E26, max 10W
<b>Controllo</b> Control	Dimmer integrato nel cavo di alimentazione Power cable with integrated dimmer
<b>Certificazioni</b> Certifications	CE

AVA

David Lopez Quincoces











IT Ava è un racconto di chiaroscuri che si caratterizza per purezza, essenzialità ed estrema cura nell'assemblaggio: l'utilizzo della paglia di Vienna accoppiata con un tessuto di lino come diffusore, creano un piacevole e rilassante effetto luminoso. La stessa lampada può essere utilizzata a sospensione o in appoggio.

EN Ava is a tale of light and shade and it is primarily characterised by purity, essentiality and the extreme care in the assembly: the use of Vienna straw and light linen fabric for the diffuser create a pleasant and relaxing luminous effect. The lamp can be used as a suspension light or free-standing piece.



Floor/table version



Pendant version

Floor/table version

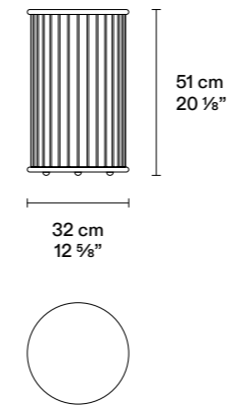

Pendant version

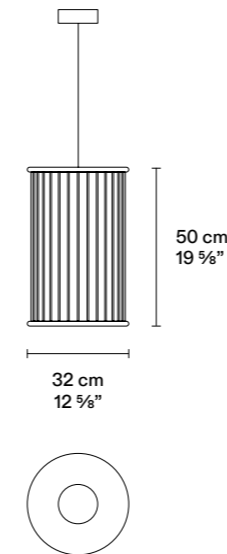

<b>Materiali</b> Materials	Legno massello, giunco, tela di cotone, metallo Solid wood, cane bark, cotton cloth, metal
<b>Finiture</b> Finishes	Frassino tinto noce Walnut-stained ash
<b>Categoria</b> Category	Da appoggio Floor/Table
<b>Specifiche tecniche</b> Technical details	EU 220÷240 V – 50/60 Hz LED E27, max 20 W  USA 100÷120 V – 50/60 Hz LED E26, max 21 W
<b>Controllo</b> Control	Dimmer integrato nel cavo di alimentazione Power cable with integrated dimmer
<b>Certificazioni</b> Certifications	CE

<b>Materiali</b> Materials	Legno massello, giunco, tela di cotone, metallo Solid wood, cane bark, cotton cloth, metal
<b>Finiture</b> Finishes	Frassino tinto noce Walnut-stained ash
<b>Categoria</b> Category	Sospensione Pendant
<b>Specifiche tecniche</b> Technical details	EU 220÷240 V – 50/60 Hz LED E27, max 20 W  USA 100÷120 V – 50/60 Hz LED E26, max 21 W
<b>Controllo</b> Control	Dimmer non incluso nella lampada Dimmer not included in the lamp
<b>Certificazioni</b> Certifications	CE

BOMBORI

Time & Style *ē*dition











BOMBORI  
Time & Style edition, 2020

IT Bombori è una lampada completamente realizzata a mano in listelli di legno di cedro Akita e carta Mino washi sottile e traslucida. Disponibile a sospensione, da terra o da appoggio, Bombori fa della luce una poesia in cui si fondono forza, stabilità e gentilezza.

EN Bombori is a lamp entirely handcrafted from Akita cedar wood slats and thin, translucent Mino washi paper. Available as a pendant, floor, or table lamp, Bombori turns light into poetry—an expression where strength, stability, and gentleness come together in perfect harmony.

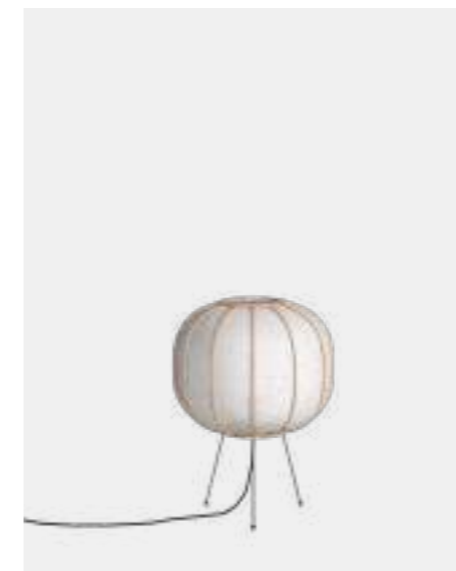

Floor version — Ø 40 cm

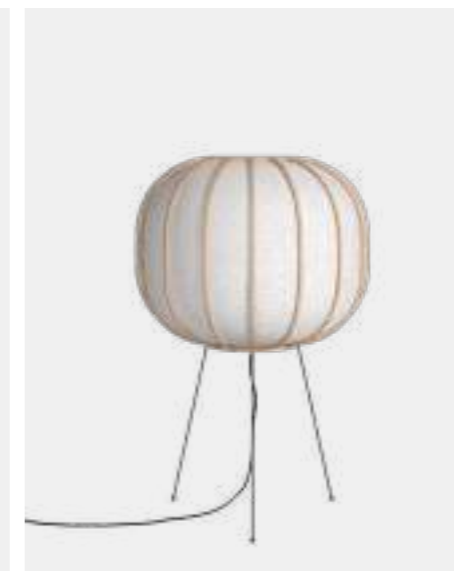

Floor version — Ø 58 cm



Floor version — Ø 78 cm



Pendant version — Ø 58 cm



Pendant version — Ø 78 cm

Floor version – Ø 40 cm

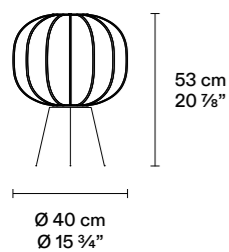

<b>Materiali Materials</b>	Legno massello, carta giapponese, acciaio Solid wood, Japanese paper, steel
<b>Finiture Finishes</b>	Carta giapponese Japanese paper
<b>Categoria Category</b>	Da terra Floor
<b>Specifiche tecniche Technical details</b>	EU 220÷240 V – 50/60 Hz LED E27, max 21 W  USA 100÷120 V – 50/60 Hz LED E26, max 21 W
<b>Controllo Control</b>	Dimmer integrato nel cavo di alimentazione Power cable with integrated dimmer
<b>Certificazioni Certifications</b>	

Floor version – Ø 58 cm

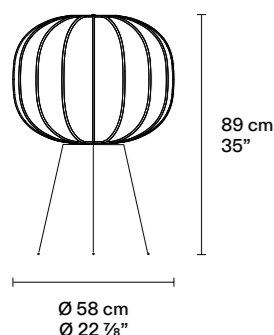

<b>Materiali Materials</b>	Legno massello, carta giapponese, acciaio Solid wood, Japanese paper, steel
<b>Finiture Finishes</b>	Carta giapponese Japanese paper
<b>Categoria Category</b>	Da terra Floor
<b>Specifiche tecniche Technical details</b>	EU 220÷240 V – 50/60 Hz LED E27, max 21 W  USA 100÷120 V – 50/60 Hz LED E26, max 21 W
<b>Controllo Control</b>	Dimmer integrato nel cavo di alimentazione Power cable with integrated dimmer
<b>Certificazioni Certifications</b>	

Floor version – Ø 78 cm

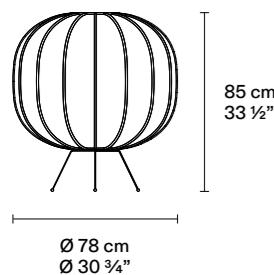

<b>Materiali Materials</b>	Legno massello, carta giapponese, acciaio Solid wood, Japanese paper, steel
<b>Finiture Finishes</b>	Carta giapponese Japanese paper
<b>Categoria Category</b>	Da terra Floor
<b>Specifiche tecniche Technical details</b>	EU 220÷240 V – 50/60 Hz LED E27, max 21 W  USA 100÷120 V – 50/60 Hz LED E26, max 21 W
<b>Controllo Control</b>	Dimmer integrato nel cavo di alimentazione Power cable with integrated dimmer
<b>Certificazioni Certifications</b>	

Pendant version – Ø 58 cm

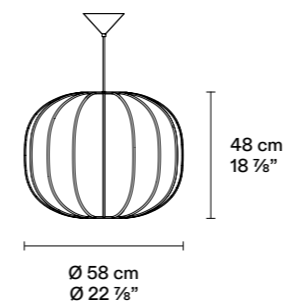

<b>Materiali Materials</b>	Legno massello, carta giapponese, acciaio Solid wood, Japanese paper, steel
<b>Finiture Finishes</b>	Carta giapponese Japanese paper
<b>Categoria Category</b>	Sospensione Pendant
<b>Specifiche tecniche Technical details</b>	EU 220÷240V – 50/60Hz LED E27, max 21W  USA 100÷120V – 50/60Hz LED E26, max 21W
<b>Controllo Control</b>	Dimmer non incluso Dimmer not included
<b>Certificazioni Certifications</b>	

Pendant version – Ø 78 cm

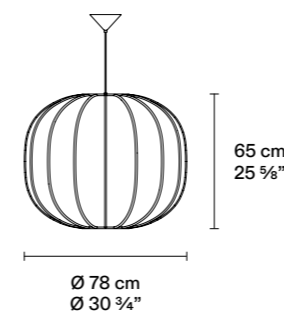

<b>Materiali Materials</b>	Legno massello, carta giapponese, acciaio Solid wood, Japanese paper, steel
<b>Finiture Finishes</b>	Carta giapponese Japanese paper
<b>Categoria Category</b>	Sospensione Pendant
<b>Specifiche tecniche Technical details</b>	EU 220÷240V – 50/60Hz LED E27, max 21W  USA 100÷120V – 50/60Hz LED E26, max 21W
<b>Controllo Control</b>	Dimmer non incluso Dimmer not included
<b>Certificazioni Certifications</b>	

CUT BACK

David Lopez Quincoces









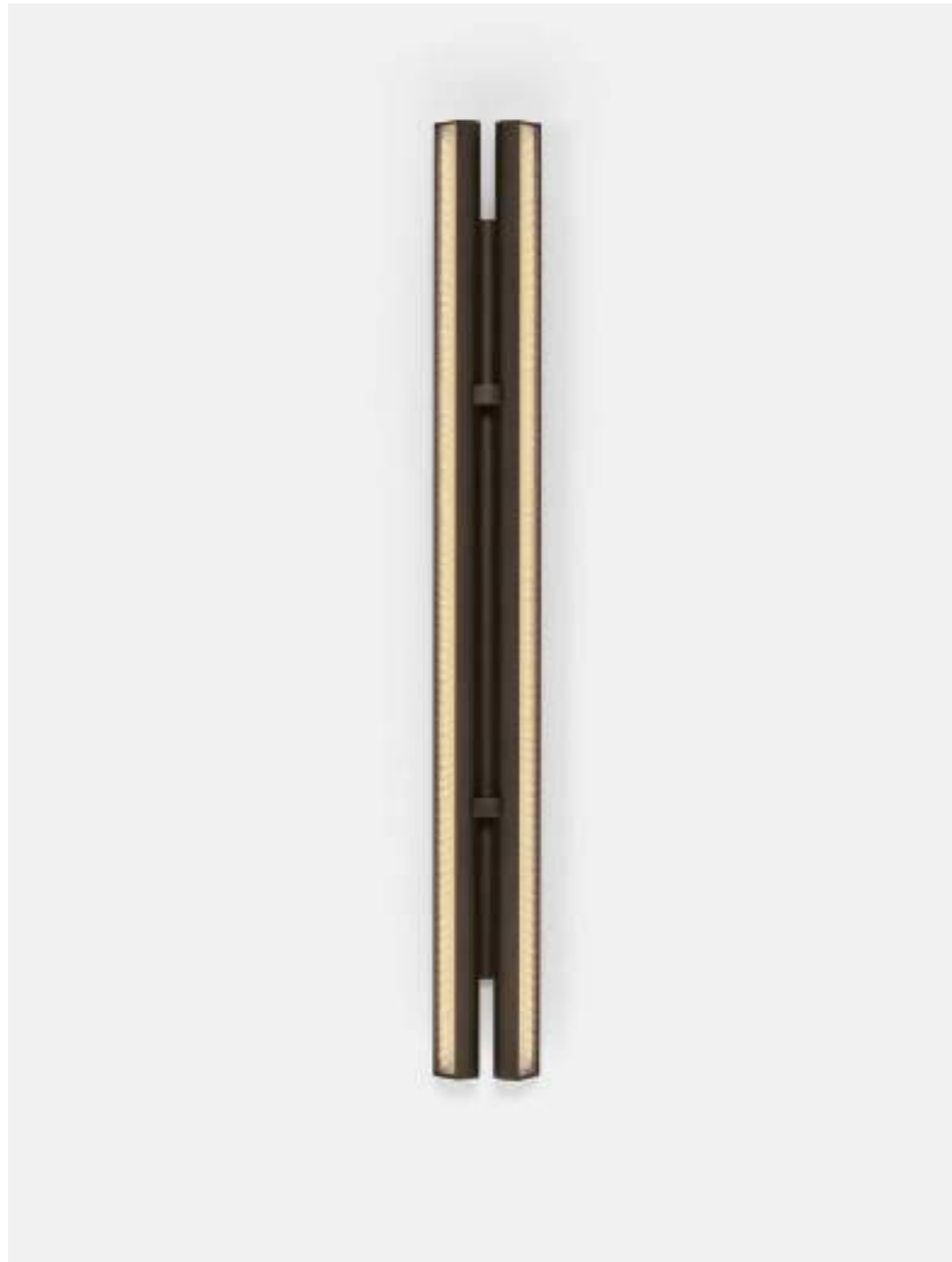





















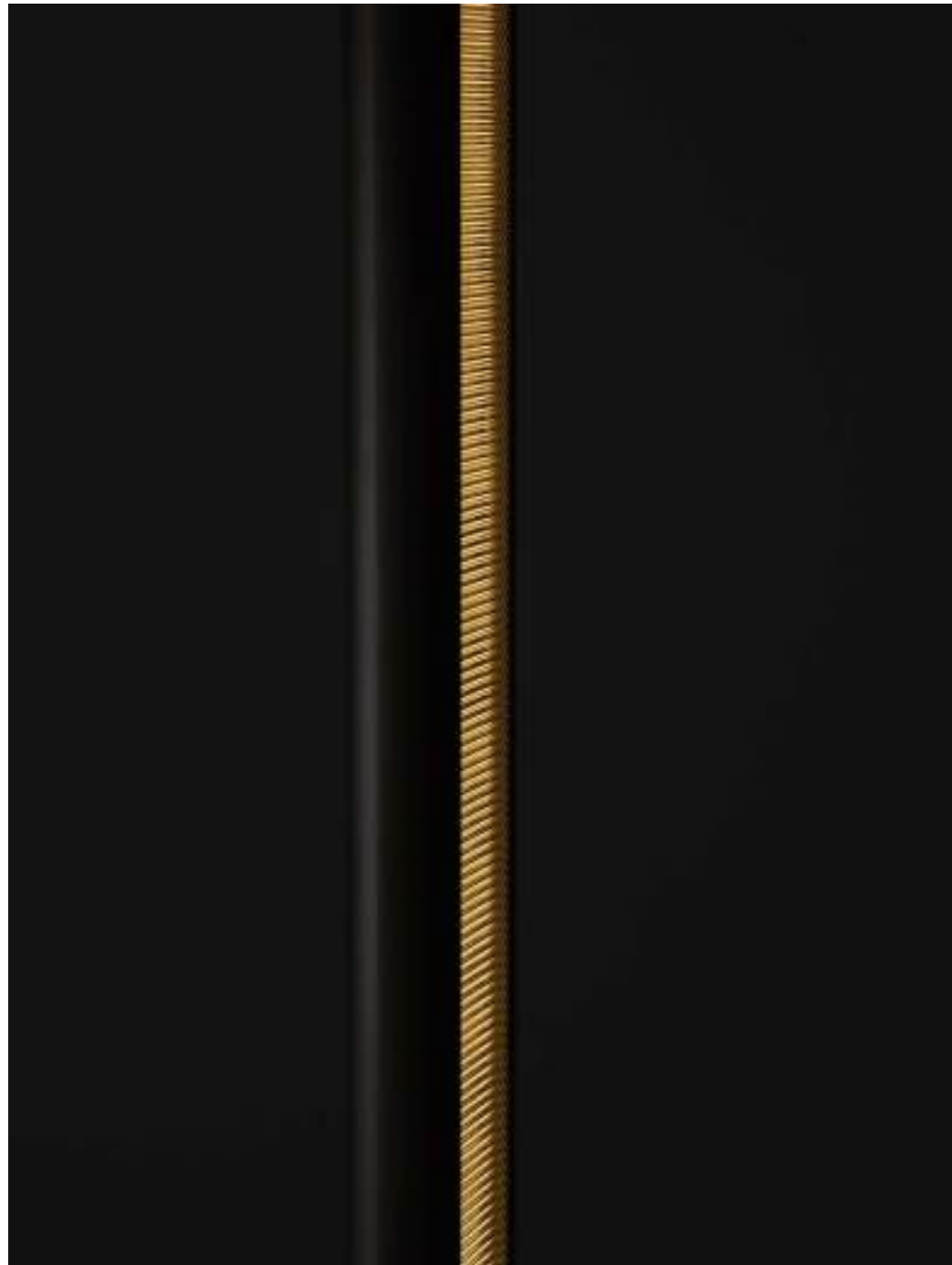

CUT BACK  
David Lopez Quincoces, 2024

IT Cut Back è un'interpretazione raffinata della luce, un equilibrio perfetto tra forma e funzione. La finitura in bronzo satinato avvolge la struttura in estruso di alluminio con un'eleganza discreta, mentre il pannello frontale in vetro millerighe, diffonde la luce in modo morbido e avvolgente. Al centro di ogni elemento, una sottile pellicola in bronzo amplifica i riflessi, regalando un'atmosfera intima e sofisticata. Cut Back si presta a composizioni a sospensione, come lampada da terra, a parete e in versione terra-soffitto.

EN Cut Back is a refined interpretation of light, striking a perfect balance between form and function. The satin bronze finish envelops the extruded aluminum structure with subtle elegance, while the reeded glass front panel diffuses the light softly and warmly. At the center of each element, a thin bronze film enhances reflections, creating an intimate and sophisticated atmosphere. Cut Back lends itself to various compositions: as a pendant, floor lamp, wall light, or in a floor-to-ceiling version.



Wall version — H 100 cm



Wall version — H 150 cm



Pendant version — H 178 cm

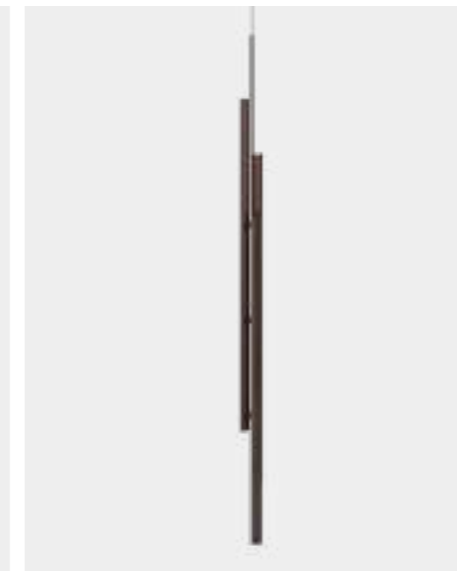

Pendant version — H 227 cm



Floor version

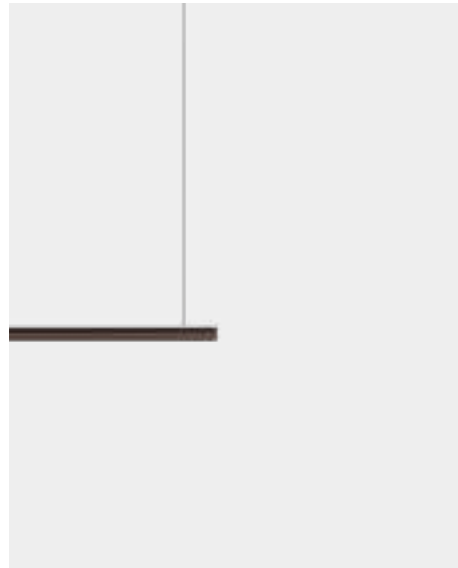

Linear version – L 150 cm

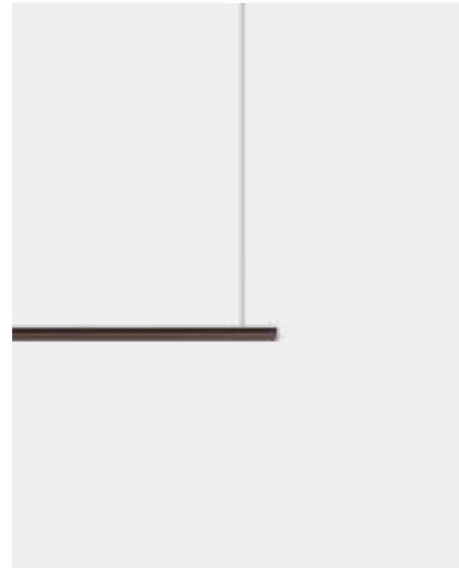

Linear version – L 200 cm

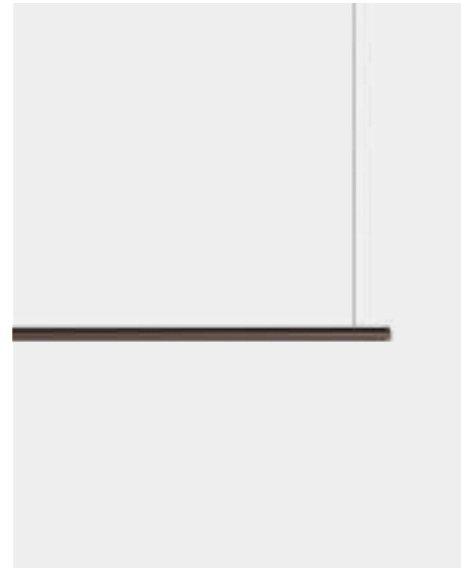

Linear version – L 300 cm

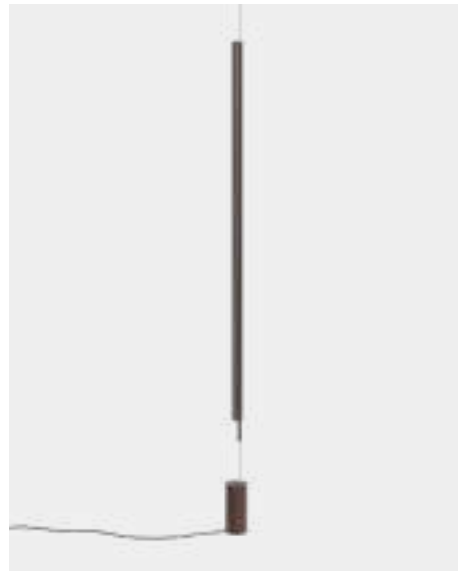

Up&Down version

Wall version – H 100 cm

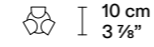
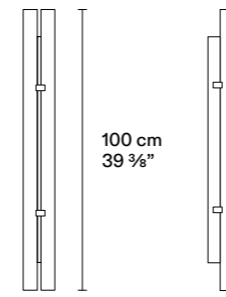

<b>Materiali</b> Materials	Alluminio, vetro millerighe Aluminium, ribbed glass
<b>Finiture</b> Finishes	Bronzo satinato Satin bronze
<b>Categoria</b> Category	Da parete Wall
<b>Specifiche tecniche</b> Technical details	100÷240 V – 50/60 Hz LED 40W, 24 V, 2700K, CRI80
<b>Controllo</b> Control	Dimmer metal touch integrato Metal touch dimmer integrated
<b>Certificazioni</b> Certifications	

Wall version – H 150 cm

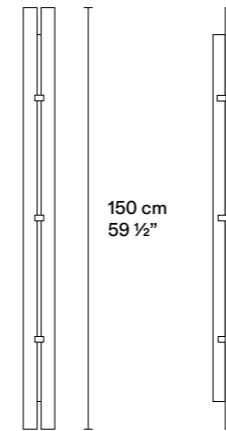

<b>Materiali</b> Materials	Alluminio, vetro millerighe Aluminium, ribbed glass
<b>Finiture</b> Finishes	Bronzo satinato Satin bronze
<b>Categoria</b> Category	Da parete Wall
<b>Specifiche tecniche</b> Technical details	100÷240 V – 50/60 Hz LED 40W, 24 V, 2700K, CRI80
<b>Controllo</b> Control	Dimmer metal touch integrato Metal touch dimmer integrated
<b>Certificazioni</b> Certifications	

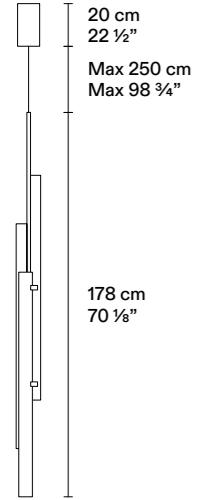

Pendant version – H 178 cm

Ø 10 cm  
Ø 3 7/8"



10 cm  
3 7/8"

11 cm  
4 3/8"

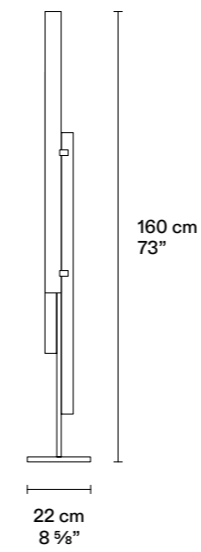

<b>Materiali</b> Materials	Alluminio, vetro millerighe Aluminium, ribbed glass
<b>Finiture</b> Finishes	Bronzo satinato Satin bronze
<b>Categoria</b> Category	Sospensione Pendant
<b>Specifiche tecniche</b> Technical details	100÷240 V – 50/60 Hz LED 60 W, 24 V, 2700K, CRI80
	IP20  
<b>Controllo</b> Control	Dimmer integrato nel rosone Ceiling rose with integrated dimmer (PUSH / 0-10 / DALI / CUT PHASE)
<b>Certificazioni</b> Certifications	

Floor version



10 cm  
3 7/8"

11 cm  
4 3/8"

<b>Materiali</b> Materials	Alluminio, vetro millerighe Aluminium, ribbed glass
<b>Finiture</b> Finishes	Bronzo satinato Satin bronze
<b>Categoria</b> Category	Da terra Floor
<b>Specifiche tecniche</b> Technical details	100÷240 V – 50/60 Hz LED 60 W, 24 V, 2700K, CRI80
	IP20  
<b>Controllo</b> Control	Dimmer metal touch integrato Metal touch dimmer integrated
<b>Certificazioni</b> Certifications	

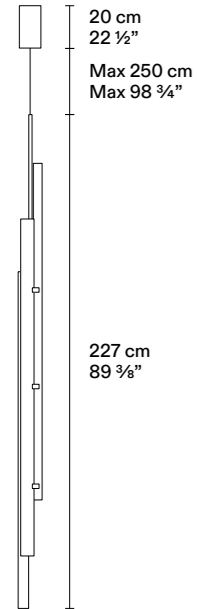

Pendant version – H 227 cm

Ø 10 cm  
Ø 3 7/8"







10 cm  
3 7/8"

11 cm  
4 3/8"

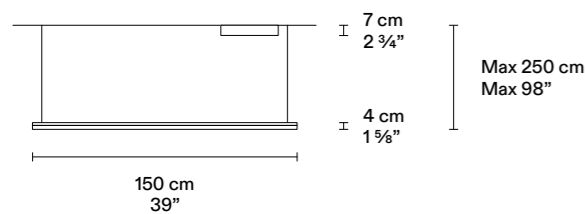
<b>Materiali</b> Materials	Alluminio, vetro millerighe Aluminium, ribbed glass
<b>Finiture</b> Finishes	Bronzo satinato Satin bronze
<b>Categoria</b> Category	Sospensione Pendant
<b>Specifiche tecniche</b> Technical details	100÷240 V – 50/60 Hz LED 90 W, 24 V, 2700K, CRI80
	IP20  
<b>Controllo</b> Control	Dimmer integrato nel rosone Ceiling rose with integrated dimmer (PUSH / 0-10 / DALI / CUT PHASE)
<b>Certificazioni</b> Certifications	



Linear version – L 150 cm



<b>Materiali</b> Materials	Alluminio, vetro millerighe Aluminium, ribbed glass
<b>Finiture</b> Finishes	Bronzo satinato Satin bronze
<b>Categoria</b> Category	Sospensione Pendant
<b>Specifiche tecniche</b> Technical details	100÷240 V – 50/60 Hz LED 24 W, 24 V, 2700K, CRI80
	IP20  
<b>Controllo</b> Control	Dimmer integrato nel rosone Ceiling rose with integrated dimmer (PUSH / 0-10 / DALI / CUT PHASE)
<b>Certificazioni</b> Certifications	

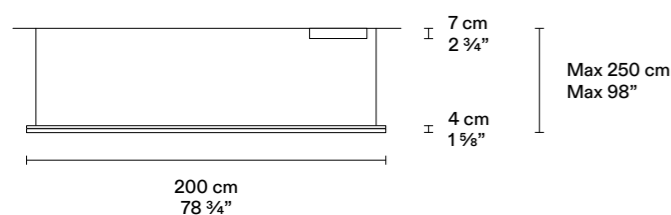

Linear version – L 200 cm



<b>Materiali</b> Materials	Alluminio, vetro millerighe Aluminium, ribbed glass
<b>Finiture</b> Finishes	Bronzo satinato Satin bronze
<b>Categoria</b> Category	Sospensione Pendant
<b>Specifiche tecniche</b> Technical details	100÷240 V – 50/60 Hz LED 32 W, 24 V, 2700K, CRI80
	IP20  
<b>Controllo</b> Control	Dimmer integrato nel rosone Ceiling rose with integrated dimmer (PUSH / 0-10 / DALI / CUT PHASE)
<b>Certificazioni</b> Certifications	

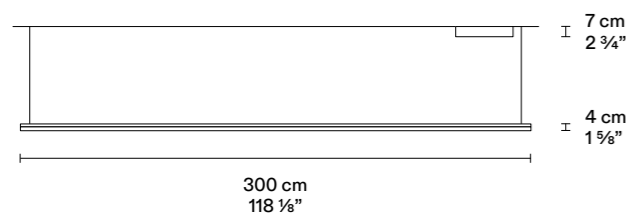

Linear version – L 300 cm

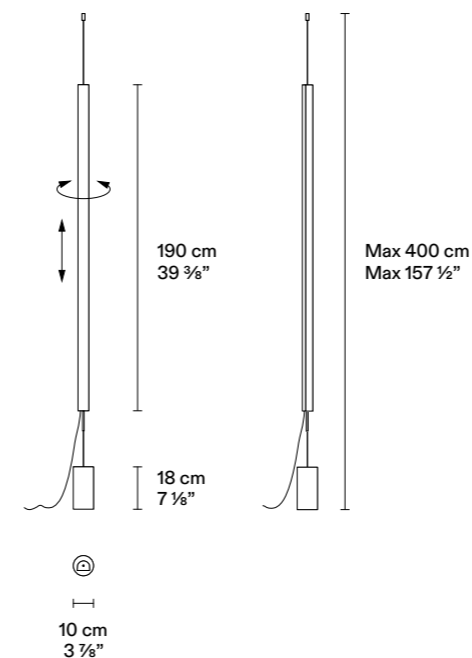

<b>Materiali</b> Materials	Alluminio, vetro millerighe Aluminium, ribbed glass
<b>Finiture</b> Finishes	Bronzo satinato Satin bronze
<b>Categoria</b> Category	Sospensione Pendant
<b>Specifiche tecniche</b> Technical details	100÷240 V – 50/60 Hz LED 48 W, 24 V, 2700K, CRI80
	IP20  
<b>Controllo</b> Control	Dimmer integrato nel rosone Ceiling rose with integrated dimmer (PUSH / 0-10 / DALI / CUT PHASE)
<b>Certificazioni</b> Certifications	

Up&Down version



<b>Materiali</b> Materials	Alluminio, vetro millerighe Aluminium, ribbed glass
<b>Finiture</b> Finishes	Bronzo satinato Satin bronze
<b>Categoria</b> Category	Terra-soffitto Floor-to-ceiling
<b>Specifiche tecniche</b> Technical details	100÷240 V – 50/60 Hz LED 28 W, 24 V, 2700K, CRI80
	IP20  
<b>Controllo</b> Control	Dimmer integrato nel kit di alimentazione e controllo Power supply and control kit with integrated dimmer
<b>Certificazioni</b> Certifications	

DROP PAPER LAMP

Claesson Koivisto Rune











IT Drop Paper Lamp, a sospensione o da terra, è realizzata con le tecniche tradizionali del villaggio Suifu, località nota per la produzione di lanterne in carta resistenti e robuste. Il paralume è in carta washi di Echizen, caratterizzata da un colore caldo e dalla straordinaria resistenza dovuta alla lunga e spessa fibra di gelso giapponese.

EN Drop Paper Lamp, available as a pendant or floor version, is crafted using the traditional techniques of the village of Suifu, a place renowned for producing strong and durable paper lanterns. The lampshade is made of Echizen washi paper, known for its warm tone and exceptional strength, thanks to the long and thick fibers of Japanese mulberry.

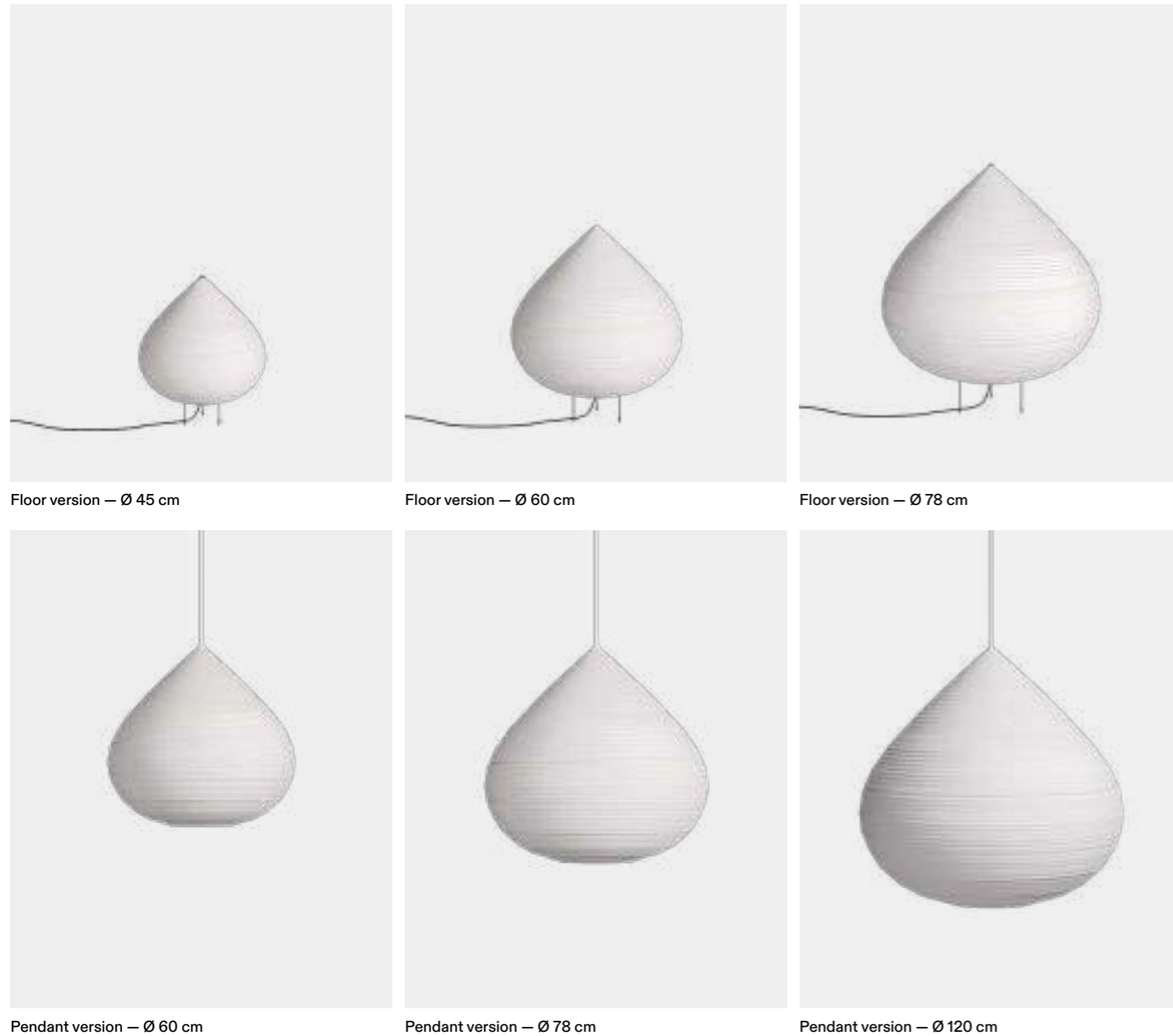

Floor version – Ø 45 cm

Floor version – Ø 60 cm

Floor version – Ø 78 cm

Pendant version – Ø 60 cm

Pendant version – Ø 78 cm

Pendant version – Ø 120 cm

Floor version – Ø 45 cm

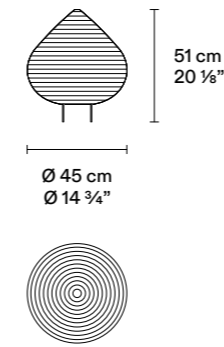

Floor version – Ø 60 cm

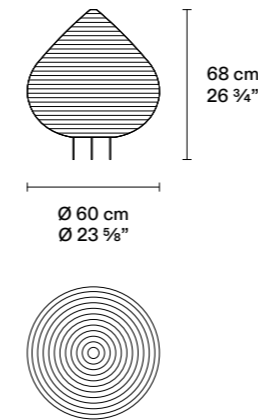

<b>Materiali</b> Materials	Carta giapponese, acciaio Japanese paper, steel
<b>Finiture</b> Finishes	Carta giapponese Japanese paper
<b>Categoria</b> Category	Da terra Floor
<b>Specifiche tecniche</b> Technical details	EU 220÷240 V – 50/60 Hz LED E27 G60, max 10 W  USA 100÷120 V – 50/60 Hz LED E26 G60, max 10 W
<b>Controllo</b> Control	Dimmer integrato nel cavo di alimentazione Power cable with integrated dimmer
<b>Certificazioni</b> Certifications	CE

<b>Materiali</b> Materials	Carta giapponese, acciaio Japanese paper, steel
<b>Finiture</b> Finishes	Carta giapponese Japanese paper
<b>Categoria</b> Category	Da terra Floor
<b>Specifiche tecniche</b> Technical details	EU 220÷240 V – 50/60 Hz LED E27, max 20 W  USA 100÷120 V – 50/60 Hz LED E26, max 20 W
<b>Controllo</b> Control	Dimmer integrato nel cavo di alimentazione Power cable with integrated dimmer
<b>Certificazioni</b> Certifications	CE

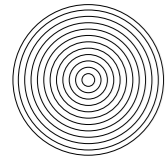
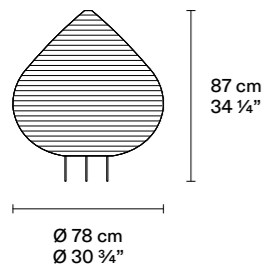

Floor version – Ø 78 cm



<b>Materiali</b> Materials	Carta giapponese, acciaio Japanese paper, steel
<b>Finiture</b> Finishes	Carta giapponese Japanese paper
<b>Categoria</b> Category	Da terra Floor
<b>Specifiche tecniche</b> Technical details	EU 220÷240 V – 50/60 Hz LED E27, max 20 W  USA 100÷120 V – 50/60 Hz LED E26, max 20 W
<b>Controllo</b> Control	Dimmer integrato nel cavo di alimentazione Power cable with integrated dimmer
<b>Certificazioni</b> Certifications	 

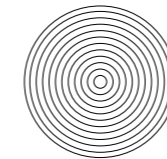
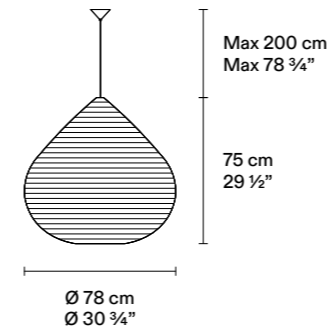

Pendant version – Ø 78 cm



<b>Materiali</b> Materials	Carta giapponese, acciaio Japanese paper, steel
<b>Finiture</b> Finishes	Carta giapponese Japanese paper
<b>Categoria</b> Category	Sospensione Pendant
<b>Specifiche tecniche</b> Technical details	EU 220÷240 V – 50/60 Hz LED E27, max 20 W  USA 100÷120 V – 50/60 Hz LED E26, max 20 W
<b>Controllo</b> Control	Dimmer integrato nel cavo di alimentazione Power cable with integrated dimmer
<b>Certificazioni</b> Certifications	 

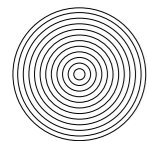
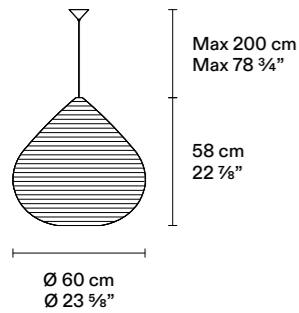

Pendant version – Ø 60 cm

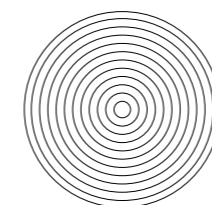
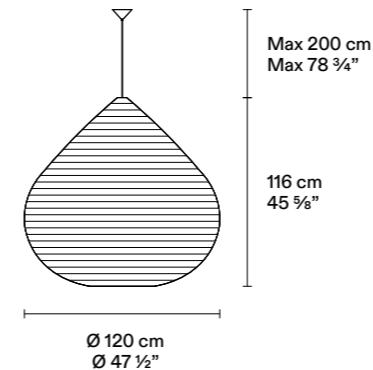

<b>Materiali</b> Materials	Carta giapponese, acciaio Japanese paper, steel
<b>Finiture</b> Finishes	Carta giapponese Japanese paper
<b>Categoria</b> Category	Sospensione Pendant
<b>Specifiche tecniche</b> Technical details	EU 220÷240 V – 50/60 Hz LED E27, max 20 W  USA 100÷120 V – 50/60 Hz LED E26, max 20 W
<b>Controllo</b> Control	Dimmer non incluso Not included dimmer
<b>Certificazioni</b> Certifications	 

Pendant version – Ø 120 cm



<b>Materiali</b> Materials	Carta giapponese, acciaio Japanese paper, steel
<b>Finiture</b> Finishes	Carta giapponese Japanese paper
<b>Categoria</b> Category	Sospensione Pendant
<b>Specifiche tecniche</b> Technical details	EU 220÷240 V – 50/60 Hz LED E27, max 20 W  USA 100÷120 V – 50/60 Hz LED E26, max 20 W
<b>Controllo</b> Control	Dimmer non incluso Not included dimmer
<b>Certificazioni</b> Certifications	 

DT LIGHT 25

Phil Luithlen



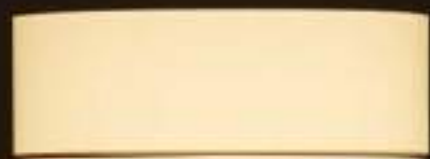









IT DT Light 25 unisce la leggerezza di una lampada a sospensione con la stabilità di una piantana, dando vita a un'illuminazione fluida e dinamica. Questa lampada si rinnova con materiali e finiture inedite, mantenendo intatta la sua anima essenziale. Il braccio, elegantemente sospeso al soffitto tramite un sottile cavo d'acciaio, si bilancia a terra grazie ad un contrappeso in marmo, elemento scultoreo che ne valorizza l'estetica e ne garantisce la perfetta stabilità. La sua rotazione a 360 gradi e la regolazione in altezza, progettata per coprire fino a 4 metri terra/soffitto, la rendono un oggetto versatile, capace di adattarsi con eleganza a qualsiasi ambiente.

EN DT Light 25 combines the lightness of a pendant lamp with the stability of a floor lamp, creating a fluid and dynamic lighting solution. This updated version features new materials and finishes while preserving its essential character. Its arm, elegantly suspended from the ceiling by a thin steel cable, is grounded by a sculptural marble counterweight that enhances its aesthetic and ensures perfect stability. With 360-degree rotation and adjustable height—designed to cover up to 4 meters from floor to ceiling—this lamp is a versatile piece that adapts gracefully to any space.

Floor-to-ceiling lamp

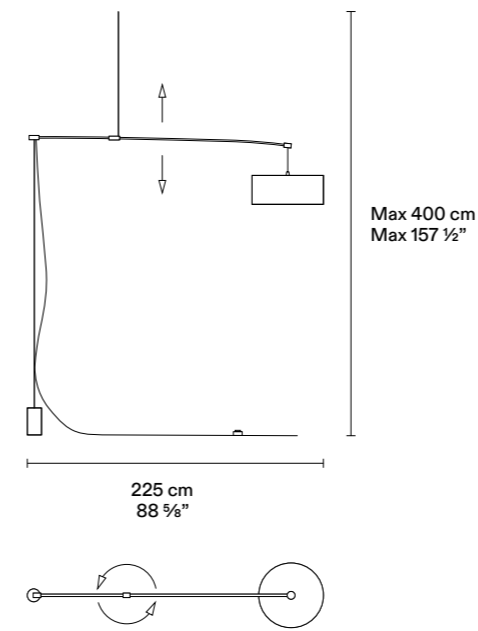

<b>Materiali</b> <b>Materials</b>	Alluminio, marmo, cotone Aluminum, marble, cotton
<b>Finiture</b> <b>Finishes</b>	Bianco "soft touch" White "soft touch"
	Marmo Calacatta Oro Calacatta marble Oro
	Nero "soft touch" Black "soft touch"
	Marmo Nero Marquinia Black Marquinia marble
<b>Categoria</b> <b>Category</b>	Terra-soffitto Floor-to-ceiling
<b>Specifiche tecniche</b> <b>Technical details</b>	EU 220÷240 V – 50/60 Hz LED 20 W, 2700 K 3 × E27, max 20 W (included)
	USA 100÷120 V – 50/60 Hz 3 × E26, max 20 W (not included)
	IP20
<b>Controllo</b> <b>Control</b>	Dimmer integrato nel cavo di alimentazione Power cable with integrated dimmer
<b>Certificazioni</b> <b>Certifications</b>	



Floor-to-ceiling lamp

ELEMENTI

Elisa Ossino















IT L'essenza della lampada Elementi risiede nella libertà compositiva, nella possibilità di moltiplicare e combinare le sue sfere luminose in un gioco di equilibri e riflessi. Oltre alle configurazioni sospese, Elementi si declina anche nella sua versione da terra, mantenendo intatta la sua eleganza eterea, ora arricchita dalla possibilità di regolare l'intensità luminosa grazie al dimmer integrato.

EN The essence of the Elementi lamp lies in its compositional freedom—the ability to multiply and combine its glowing spheres in a play of balance and reflection. Alongside its suspended configurations, Elementi is now also available in a floor version, preserving its ethereal elegance now enriched by the added functionality of adjustable light intensity thanks to the integrated dimmer.

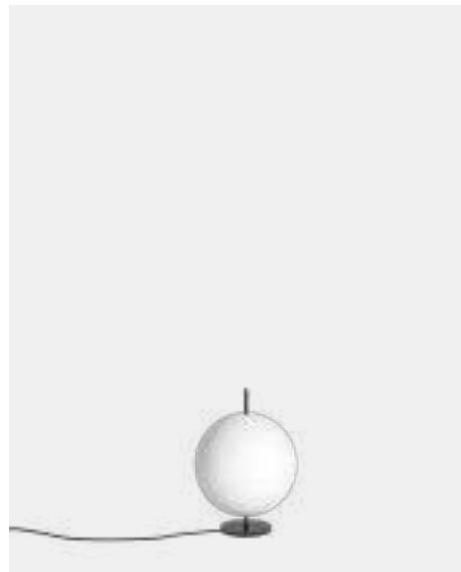

Floor/table version — Ø 30 cm



Floor/table version — Ø 45 cm



Floor version — Ø 30 cm

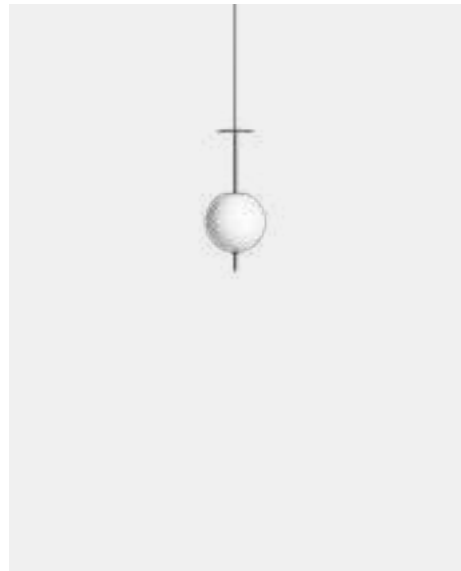

Pendant version — Ø 25 cm



Pendant version — Ø 45 cm

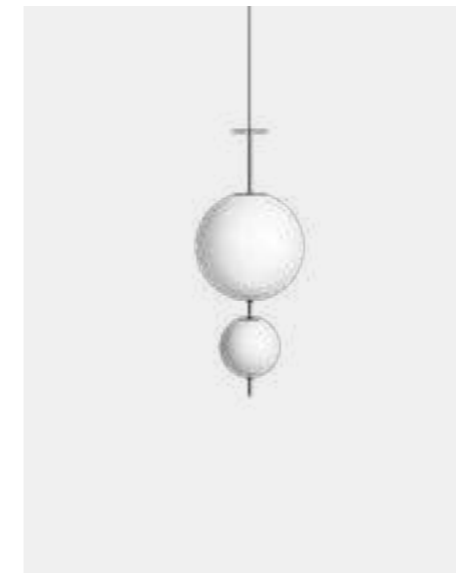

Pendant version — 2 spheres

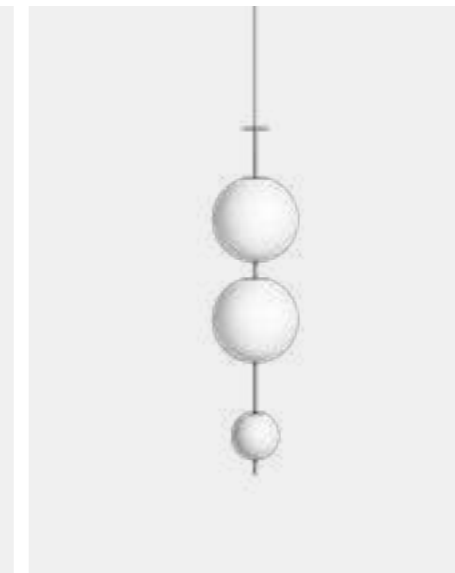

Pendant version — 3 spheres

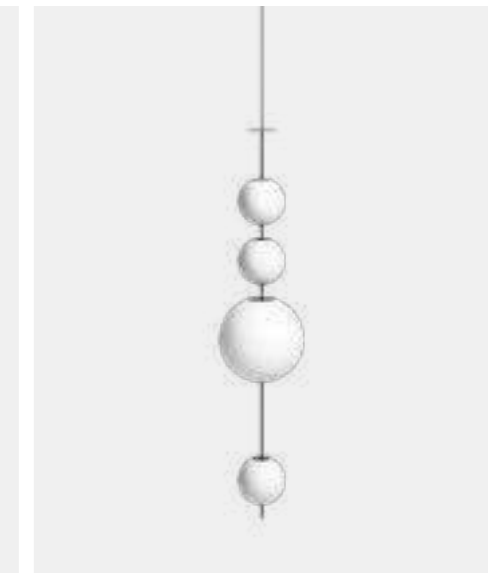

Pendant version — 4 spheres



Pendant version — 5 spheres

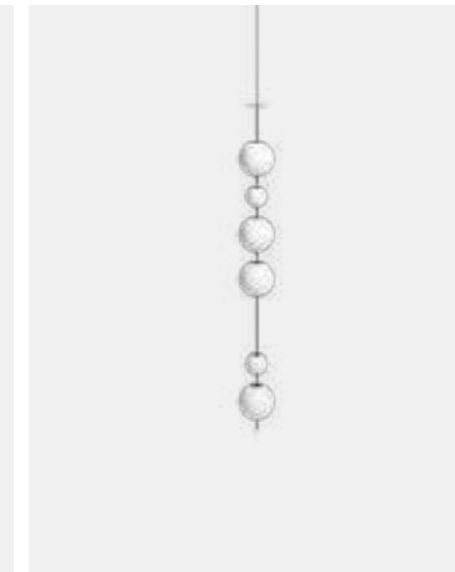

Pendant version — 6 spheres

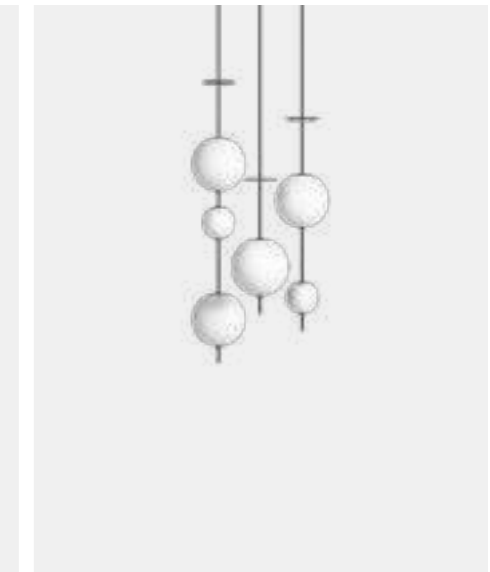

Pendant composition — 6 spheres



Pendant composition — 7 spheres

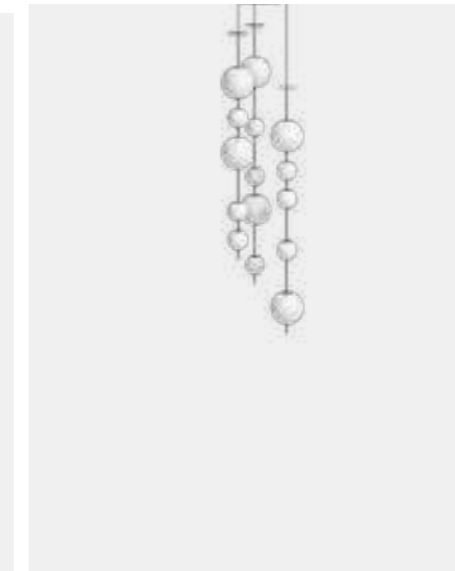



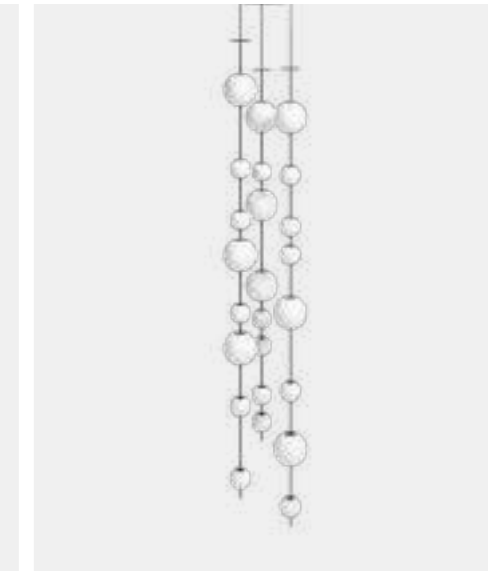

Pendant composition — 15 spheres

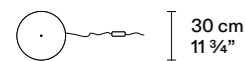
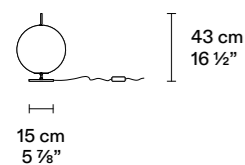

Pendant composition — 24 spheres



Floor/table version – Ø 30 cm



<b>Materiali</b> Materials	Alluminio, ottone Aluminium, brass
<b>Finiture</b> Finishes	Nero opaco "soft touch" Matt black "soft touch"
<b>Categoria</b> Category	Da appoggio Floor/table
<b>Specifiche tecniche</b> Technical details	100÷240 V – 50/60 Hz LED 16 W, 24 V, Tunable White 2700-5000K, CRI90
	IP20  
<b>Controllo</b> Control	Dimmer solo tramite app CASAMBI Dimmer controlled only via CASAMBI app
<b>Certificazioni</b> Certifications	

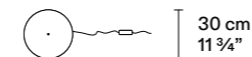
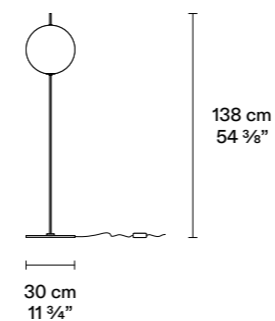

Floor version – Ø 30 cm

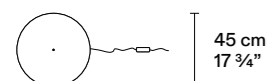
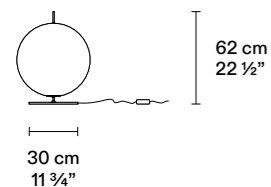

<b>Materiali</b> Materials	Alluminio, ottone Aluminium, brass
<b>Finiture</b> Finishes	Nero opaco "soft touch" Matt black "soft touch"
<b>Categoria</b> Category	Da terra Floor
<b>Specifiche tecniche</b> Technical details	100÷240 V – 50/60 Hz LED 16 W, 24 V, Tunable White 2700-5000K, CRI90
	IP20  
<b>Controllo</b> Control	Dimmer solo tramite app CASAMBI Dimmer controlled only via CASAMBI app
<b>Certificazioni</b> Certifications	

Floor/table version – Ø 45 cm



<b>Materiali</b> Materials	Alluminio, ottone Aluminium, brass
<b>Finiture</b> Finishes	Nero opaco "soft touch" Matt black "soft touch"
<b>Categoria</b> Category	Da appoggio Floor/table
<b>Specifiche tecniche</b> Technical details	100 ÷240 V – 50/60 Hz LED 32 W, 24 V, Tunable White 2700-5000K, CRI90
	IP20  
<b>Controllo</b> Control	Dimmer solo tramite app CASAMBI Dimmer controlled only via CASAMBI app
<b>Certificazioni</b> Certifications	

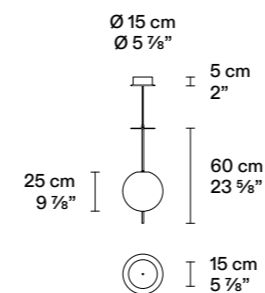

Pendant version – Ø 25 cm

EU Version



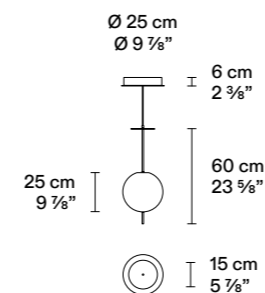



USA Version

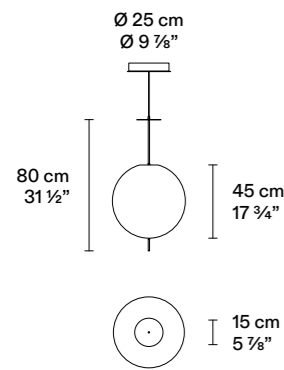

<b>Materiali</b> Materials	Alluminio, ottone Aluminium, brass
<b>Finiture</b> Finishes	Nero opaco "soft touch" Matt black "soft touch"
<b>Categoria</b> Category	Sospensione Pendant
<b>Specifiche tecniche</b> Technical details	100÷240 V – 50/60 Hz LED 16 W, 24 V, Tunable White 2700-5000K, CRI90
	IP20  
<b>Controllo</b> Control	Dimmer solo tramite app CASAMBI Dimmer controlled only via CASAMBI app
<b>Certificazioni</b> Certifications	 





Pendant version – Ø 45 cm

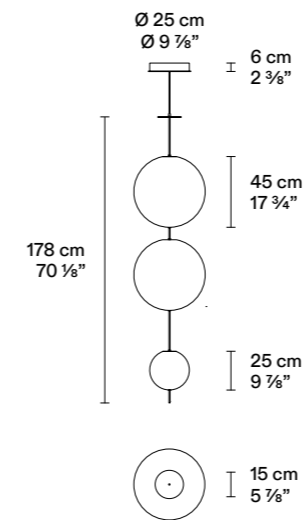

<b>Materiali</b> Materials	Alluminio, ottone Aluminium, brass
<b>Finiture</b> Finishes	Nero opaco "soft touch" Matt black "soft touch"
<b>Categoria</b> Category	Sospensione Pendant
<b>Specifiche tecniche</b> Technical details	100÷240 V – 50/60 Hz LED 32 W, 24 V, Tunable White 2700-5000K, CRI90
	IP20  
<b>Controllo</b> Control	Dimmer solo tramite app CASAMBI Dimmer controlled only via CASAMBI app
<b>Certificazioni</b> Certifications	 





Pendant version – 3 spheres

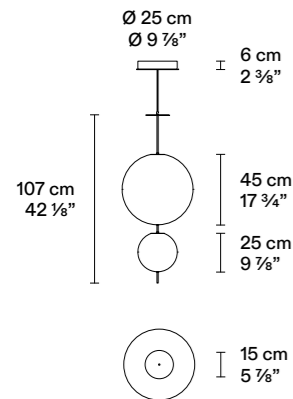

<b>Materiali</b> Materials	Alluminio, ottone Aluminium, brass
<b>Finiture</b> Finishes	Nero opaco "soft touch" Matt black "soft touch"
<b>Categoria</b> Category	Sospensione Pendant
<b>Specifiche tecniche</b> Technical details	100÷240 V – 50/60 Hz LED 80 W, 24 V, Tunable White 2700-5000K, CRI90
	IP20  
<b>Controllo</b> Control	Dimmer solo tramite app CASAMBI Dimmer controlled only via CASAMBI app
<b>Certificazioni</b> Certifications	 





Pendant version – 2 spheres

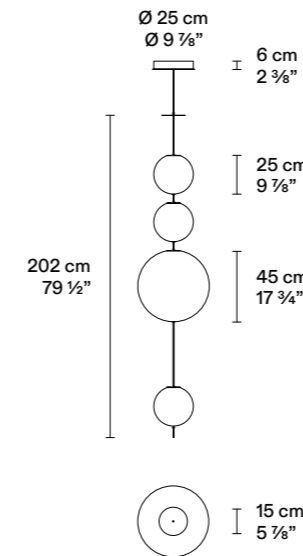

<b>Materiali</b> Materials	Alluminio, ottone Aluminium, brass
<b>Finiture</b> Finishes	Nero opaco "soft touch" Matt black "soft touch"
<b>Categoria</b> Category	Sospensione Pendant
<b>Specifiche tecniche</b> Technical details	100÷240 V – 50/60 Hz LED 48 W, 24 V, Tunable White 2700-5000K, CRI90
	IP20  
<b>Controllo</b> Control	Dimmer solo tramite app CASAMBI Dimmer controlled only via CASAMBI app
<b>Certificazioni</b> Certifications	 





Pendant version – 4 spheres

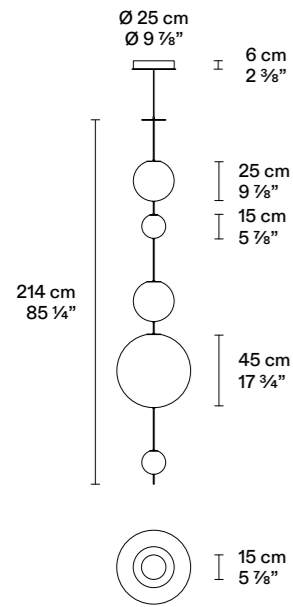

<b>Materiali</b> Materials	Alluminio, ottone Aluminium, brass
<b>Finiture</b> Finishes	Nero opaco "soft touch" Matt black "soft touch"
<b>Categoria</b> Category	Sospensione Pendant
<b>Specifiche tecniche</b> Technical details	100÷240 V – 50/60 Hz LED 80 W, 24 V, Tunable White 2700-5000K, CRI90
	IP20  
<b>Controllo</b> Control	Dimmer solo tramite app CASAMBI Dimmer controlled only via CASAMBI app
<b>Certificazioni</b> Certifications	 





Pendant version – 5 spheres

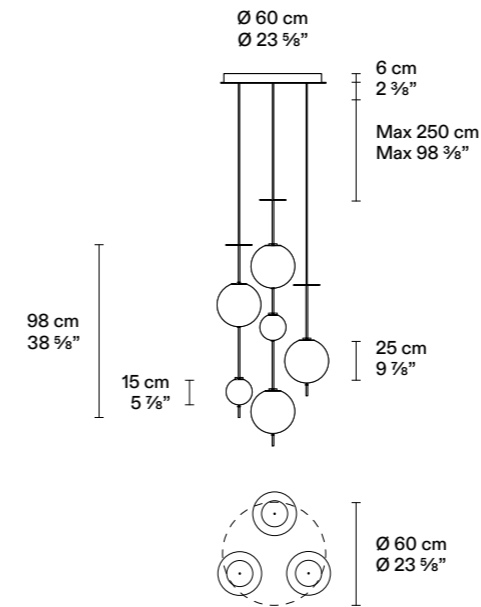

<b>Materiali</b> Materials	Alluminio, ottone Aluminium, brass
<b>Finiture</b> Finishes	Nero opaco "soft touch" Matt black "soft touch"
<b>Categoria</b> Category	Sospensione Pendant
<b>Specifiche tecniche</b> Technical details	100÷240 V – 50/60 Hz LED 80 W, 24 V, Tunable White 2700-5000K, CRI90
	IP20  
<b>Controllo</b> Control	Dimmer solo tramite app CASAMBI Dimmer controlled only via CASAMBI app
<b>Certificazioni</b> Certifications	 





Pendant composition – 6 spheres

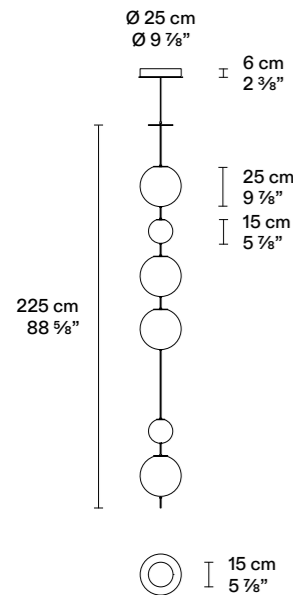

<b>Materiali</b> Materials	Alluminio, ottone Aluminium, brass
<b>Finiture</b> Finishes	Nero opaco "soft touch" Matt black "soft touch"
<b>Categoria</b> Category	Sospensione Pendant
<b>Specifiche tecniche</b> Technical details	100÷240 V – 50/60 Hz LED 80 W, 24 V, Tunable White 2700-5000K, CRI90
	IP20  
<b>Controllo</b> Control	Dimmer solo tramite app CASAMBI Dimmer controlled only via CASAMBI app
<b>Certificazioni</b> Certifications	 





Pendant version – 6 spheres

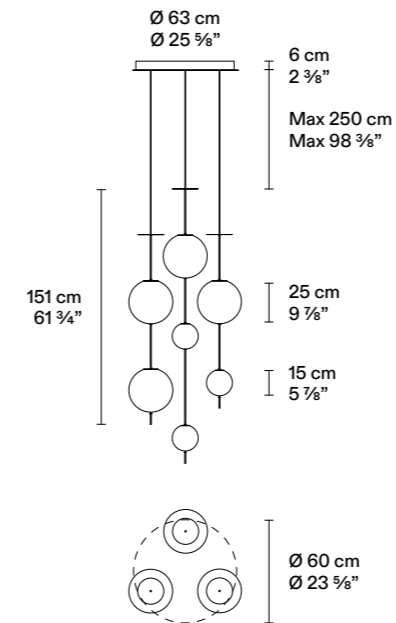

<b>Materiali</b> Materials	Alluminio, ottone Aluminium, brass
<b>Finiture</b> Finishes	Nero opaco "soft touch" Matt black "soft touch"
<b>Categoria</b> Category	Sospensione Pendant
<b>Specifiche tecniche</b> Technical details	100÷240 V – 50/60 Hz LED 80 W, 24 V, Tunable White 2700-5000K, CRI90
	IP20  
<b>Controllo</b> Control	Dimmer solo tramite app CASAMBI Dimmer controlled only via CASAMBI app
<b>Certificazioni</b> Certifications	 





Pendant composition – 7 spheres

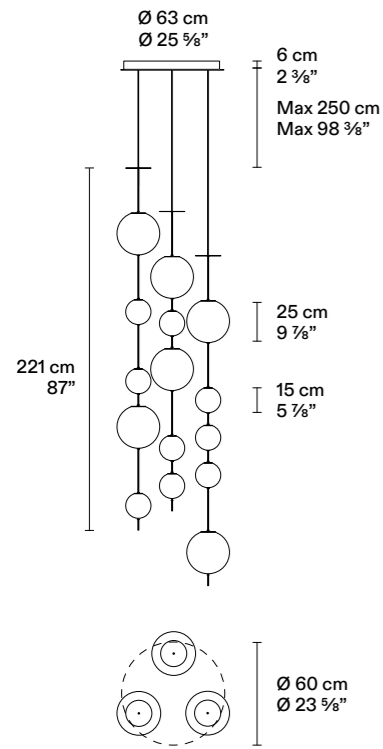

<b>Materiali</b> Materials	Alluminio, ottone Aluminium, brass
<b>Finiture</b> Finishes	Nero opaco "soft touch" Matt black "soft touch"
<b>Categoria</b> Category	Sospensione Pendant
<b>Specifiche tecniche</b> Technical details	100÷240 V – 50/60 Hz LED 88 W, 24 V, Tunable White 2700-5000K, CRI90
	IP20  
<b>Controllo</b> Control	Dimmer solo tramite app CASAMBI Dimmer controlled only via CASAMBI app
<b>Certificazioni</b> Certifications	 





Pendant composition – 15 spheres

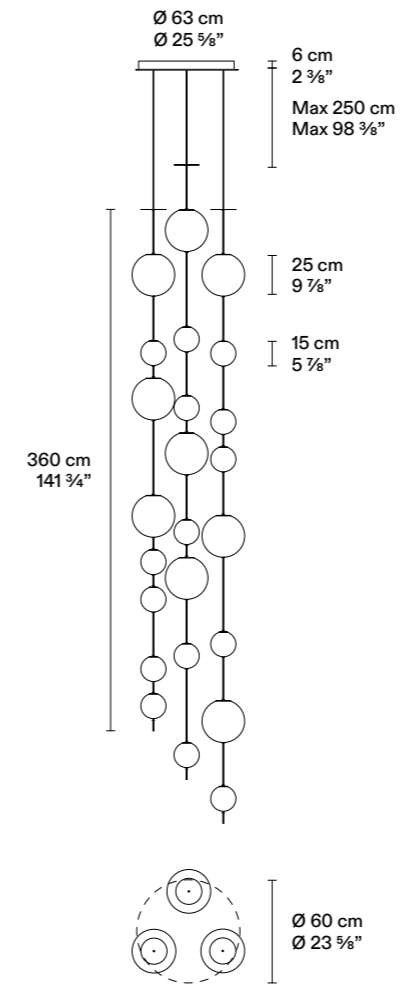

<b>Materiali</b> <b>Materials</b>	Alluminio, ottone Aluminium, brass
<b>Finiture</b> <b>Finishes</b>	Nero opaco "soft touch" Matt black "soft touch"
<b>Categoria</b> <b>Category</b>	Sospensione Pendant
<b>Specifiche tecniche</b> <b>Technical details</b>	100÷240 V – 50/60 Hz LED 168 W, 24 V, Tunable White 2700-5000K, CRI90
	IP20  
<b>Controllo</b> <b>Control</b>	Dimmer solo tramite app CASAMBI Dimmer controlled only via CASAMBI app
<b>Certificazioni</b> <b>Certifications</b>	 

Pendant composition – 24 spheres



<b>Materiali</b> <b>Materials</b>	Alluminio, ottone Aluminium, brass
<b>Finiture</b> <b>Finishes</b>	Nero opaco "soft touch" Matt black "soft touch"
<b>Categoria</b> <b>Category</b>	Sospensione Pendant
<b>Specifiche tecniche</b> <b>Technical details</b>	100÷240 V – 50/60 Hz LED 264 W, 24 V, Tunable White 2700-5000K, CRI90
	IP20  
<b>Controllo</b> <b>Control</b>	Dimmer solo tramite app CASAMBI Dimmer controlled only via CASAMBI app
<b>Certificazioni</b> <b>Certifications</b>	 

FIREFLY

Alexander Åhnebrink











FIREFLY  
Alexander Ahnebrink, 2016

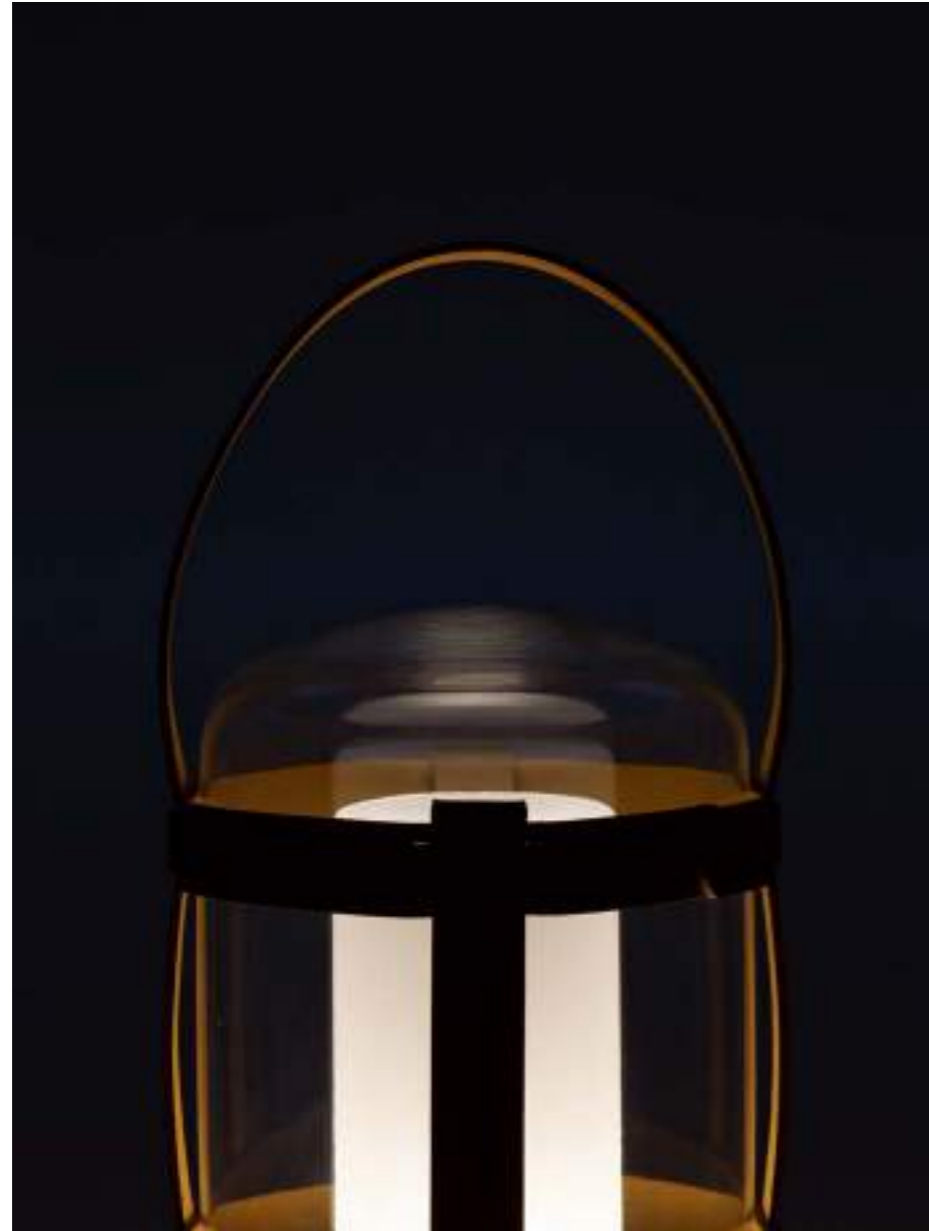

IT Una lampada nomade, da portare e spostare ovunque serva luce, dentro o fuori, senza vincoli, grazie alla batteria ricaricabile. Strisce intrecciate in cuoio naturale o in EVA – materiale outdoor che unisce resistenza e flessibilità – avvolgono i diffusori in vetro stampato. Firefly richiama per associazione la spensieratezza di un picnic dal gusto rétro. Si può appendere all'apposito piedistallo o appoggiare direttamente a terra, per illuminare liberamente ogni spazio.

EN A nomadic lamp, easy to carry and move wherever light is needed, indoors or outdoors, without constraints, thanks to its rechargeable battery. Interwoven strips in natural leather or EVA—a weather-resistant, flexible material—wrap around the moulded glass diffusers. Firefly evokes the carefree spirit of a retro-style picnic. It can be hung on its dedicated stand or placed directly on the ground, bringing light freely to any space.

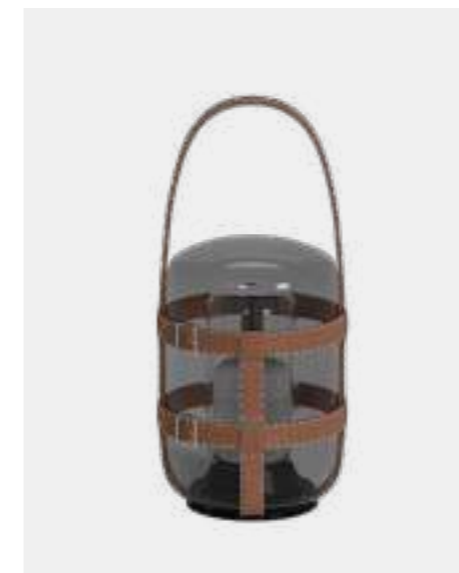

Firefly

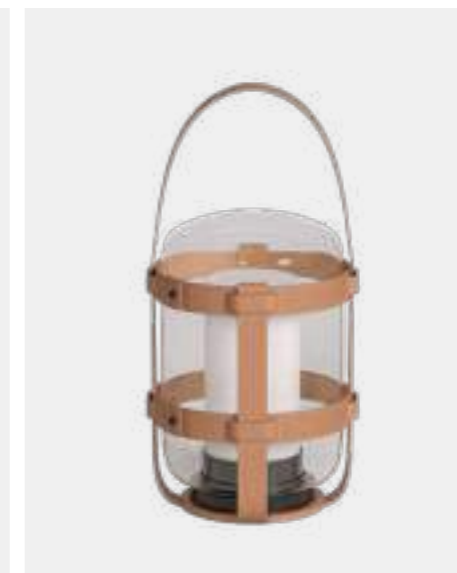







Firefly Outdoor

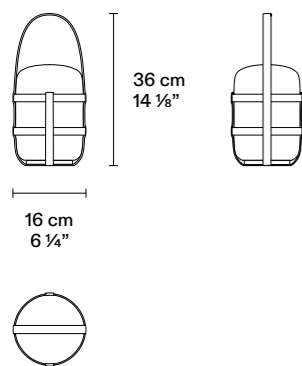

Firefly Outdoor Lampstand

### Firefly



<b>Materiali</b> Materials	Cuoio, vetro Cowhide, glass
<b>Finiture</b> Finishes	Vetro grigio Grey glass  Pelle naturale Natural leather
<b>Categoria</b> Category	Portatile Portable
<b>Specifiche tecniche</b> Technical details	100÷240 V – 50/60 Hz LED 10 W, 2700K, CRI90     
<b>Controllo</b> Control	Dimmer non incluso nella lampada Dimmer not included in the lamp
<b>Certificazioni</b> Certifications	



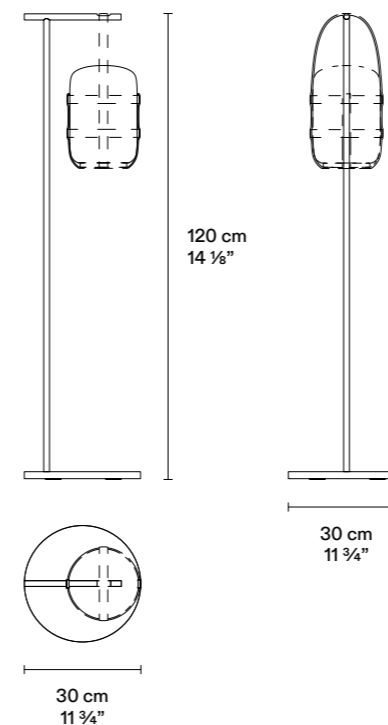

### Outdoor Lampstand

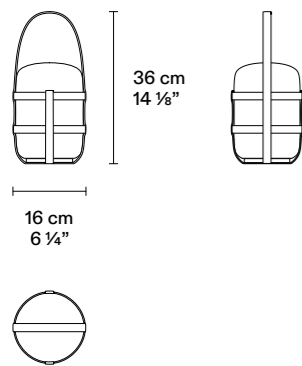

<b>Materiali</b> Materials	Acciano inox Stainless steel
<b>Finiture</b> Finishes	Grigio antracite Anthracite grey
<b>Categoria</b> Category	Piedistallo Lampstand

### Firefly Outdoor



<b>Materiali</b> Materials	EVA, vetro EVA, glass
<b>Finiture</b> Finishes	Vetro trasparente Transparent glass  EVA Cognac Cognac EVA
<b>Categoria</b> Category	Portatile, adatto ad ambienti esterni coperti Portable, sheltered outdoor use
<b>Specifiche tecniche</b> Technical details	100÷240 V – 50/60 Hz LED 10 W, 2700K, CRI90     
<b>Controllo</b> Control	Dimmer non incluso nella lampada Dimmer not included in the lamp
<b>Certificazioni</b> Certifications	

GIÒ

C.R.S. Boffi





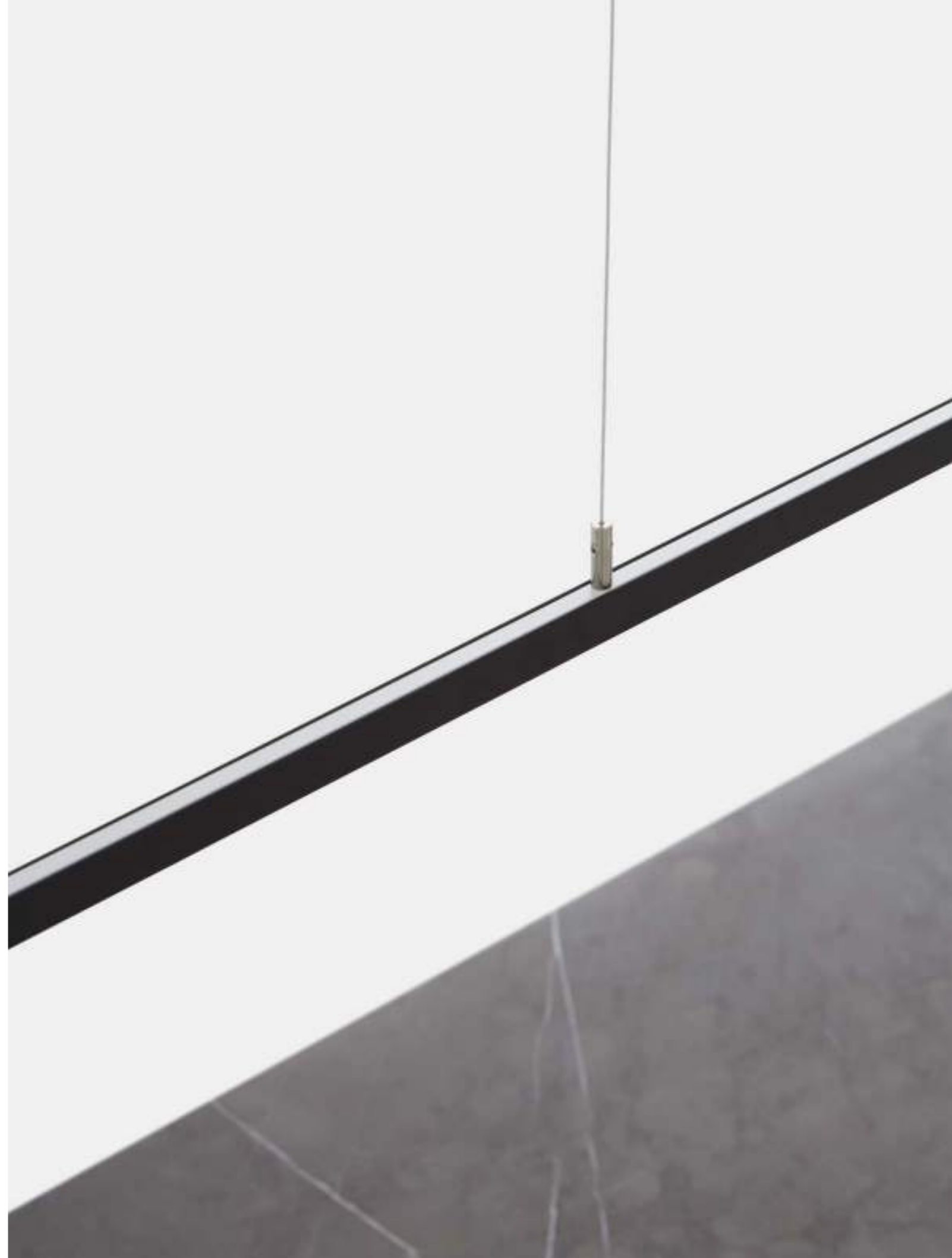

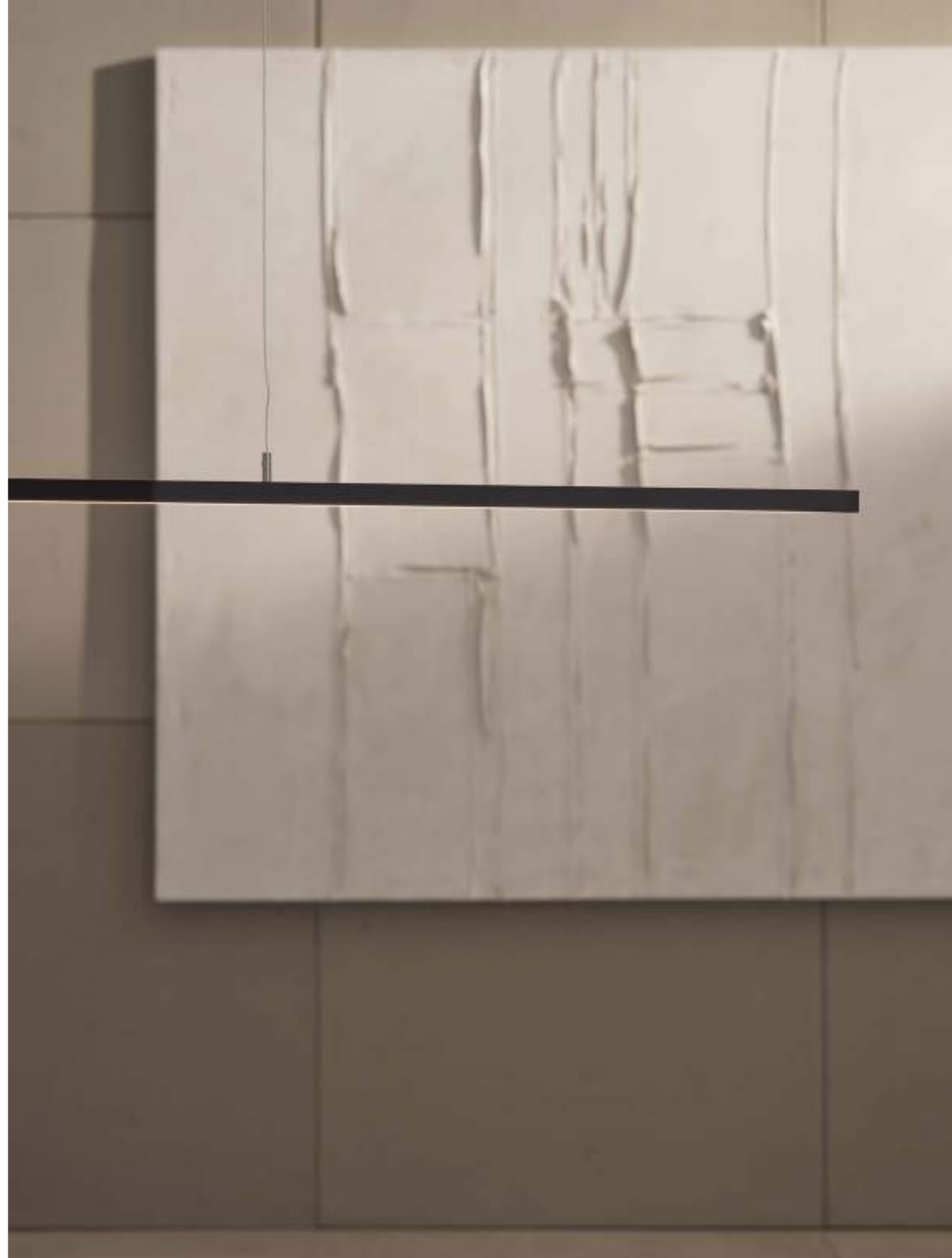



GIÒ  
C.R.S. Boffi, 2014

IT Una struttura sottilissima tratteggia questa lampada dal design basico e dalle forme essenziali. Giò delinea la luce sui profili in alluminio verniciato nero oppure bianco, vestendo ogni stanza. Una lampada a sospensione dall'animo razionale, con schermo protettivo in policarbonato e possibilità di luce dimmerabile.

EN A very thin structure outlines this lamp with a basic design and essential shapes. Giò traces the light along black or white painted aluminum profiles, dressing up any room. A suspension lamp with a rational soul, featuring a protective polycarbonate screen and dimmable light option.

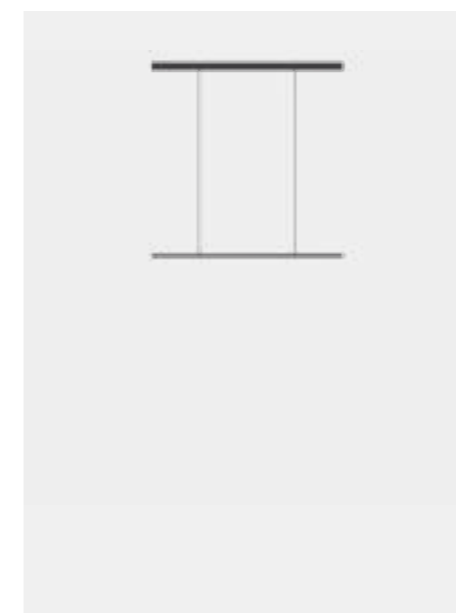

Pendant version – L 100 cm

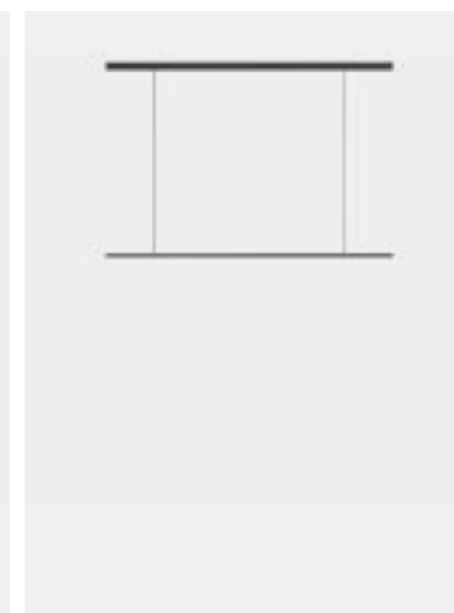



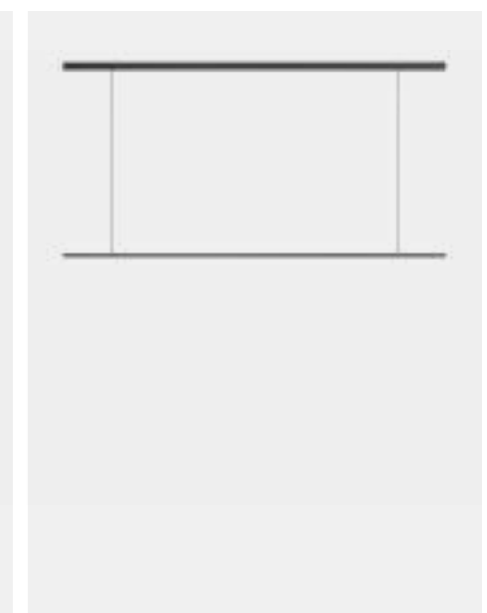

Pendant version – L 150 cm

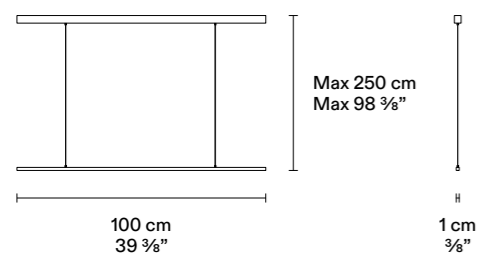

Pendant version – L 200 cm



Pendant version – L 100 cm



<b>Materiali</b> Materials	Alluminio, policarbonato Aluminium, polycarbonate
<b>Finiture</b> Finishes	Nero Black Bianco White
<b>Categoria</b> Category	Sospensione Pendant
<b>Specifiche tecniche</b> Technical details	100÷240 V – 50/60 Hz LED 20 W, 24 V, 2700K IP20  
<b>Controllo</b> Control	Versione con dimmer opzionale Version with optional dimmer (PUSH / 0-10 V / DALI / CASAMBI) Versione con controllo a sfioramento - dimmer integrato nel corpo della lampada Version with Touch control - dimmer integrated into the lamp body
<b>Certificazioni</b> Certifications	

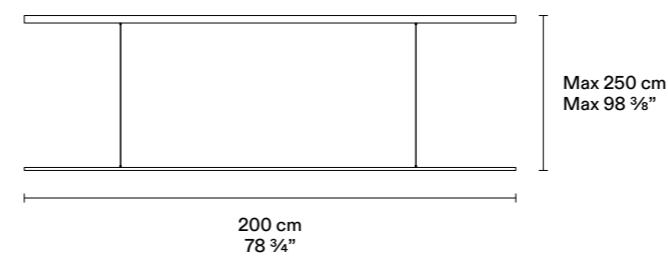

Pendant version – L 200 cm

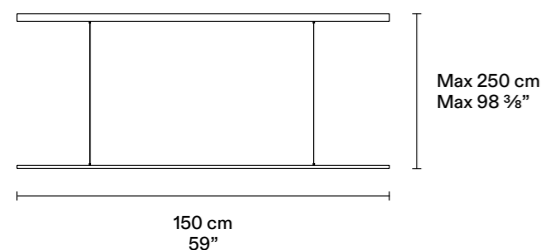

<b>Materiali</b> Materials	Alluminio Aluminium
<b>Finiture</b> Finishes	Nero Black Bianco White
<b>Categoria</b> Category	Sospensione Pendant
<b>Specifiche tecniche</b> Technical details	100÷240 V – 50/60 Hz LED 40 W, 24 V, 2700K IP20  
<b>Controllo</b> Control	Versione con dimmer opzionale Version with optional dimmer (PUSH / 0-10 V / DALI / CASAMBI) Versione con controllo a sfioramento - dimmer integrato nel corpo della lampada Version with Touch control - dimmer integrated into the lamp body
<b>Certificazioni</b> Certifications	

Pendant version – L 150 cm



<b>Materiali</b> Materials	Alluminio Aluminium
<b>Finiture</b> Finishes	Nero Black Bianco White
<b>Categoria</b> Category	Sospensione Pendant
<b>Specifiche tecniche</b> Technical details	100÷240 V – 50/60 Hz LED 30 W, 24 V, 2700K IP20  
<b>Controllo</b> Control	Versione con dimmer opzionale Version with optional dimmer (PUSH / 0-10 V / DALI / CASAMBI) Versione con controllo a sfioramento - dimmer integrato nel corpo della lampada Version with Touch control - dimmer integrated into the lamp body
<b>Certificazioni</b> Certifications	

HELIUM

Elisa Ossino







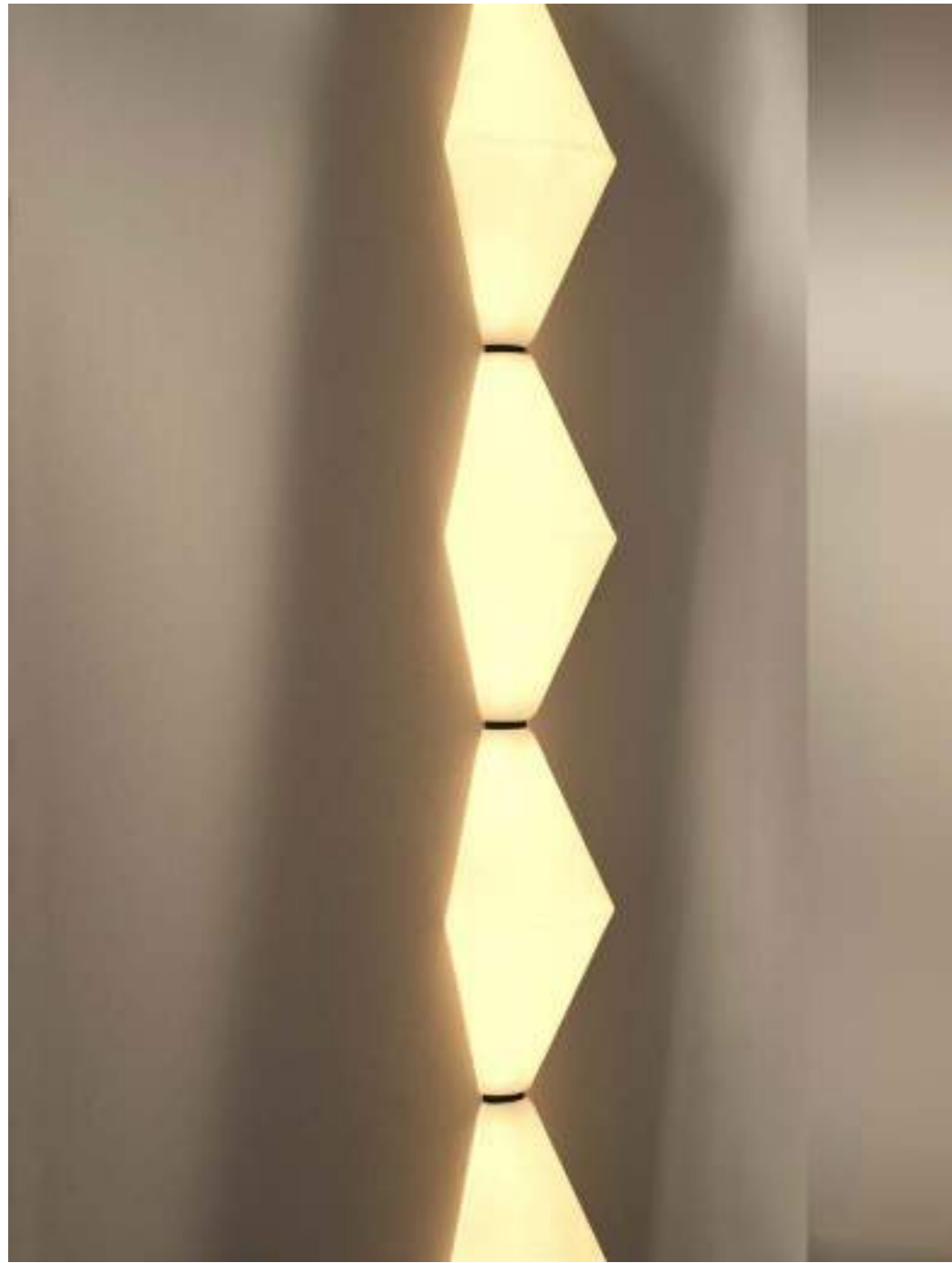

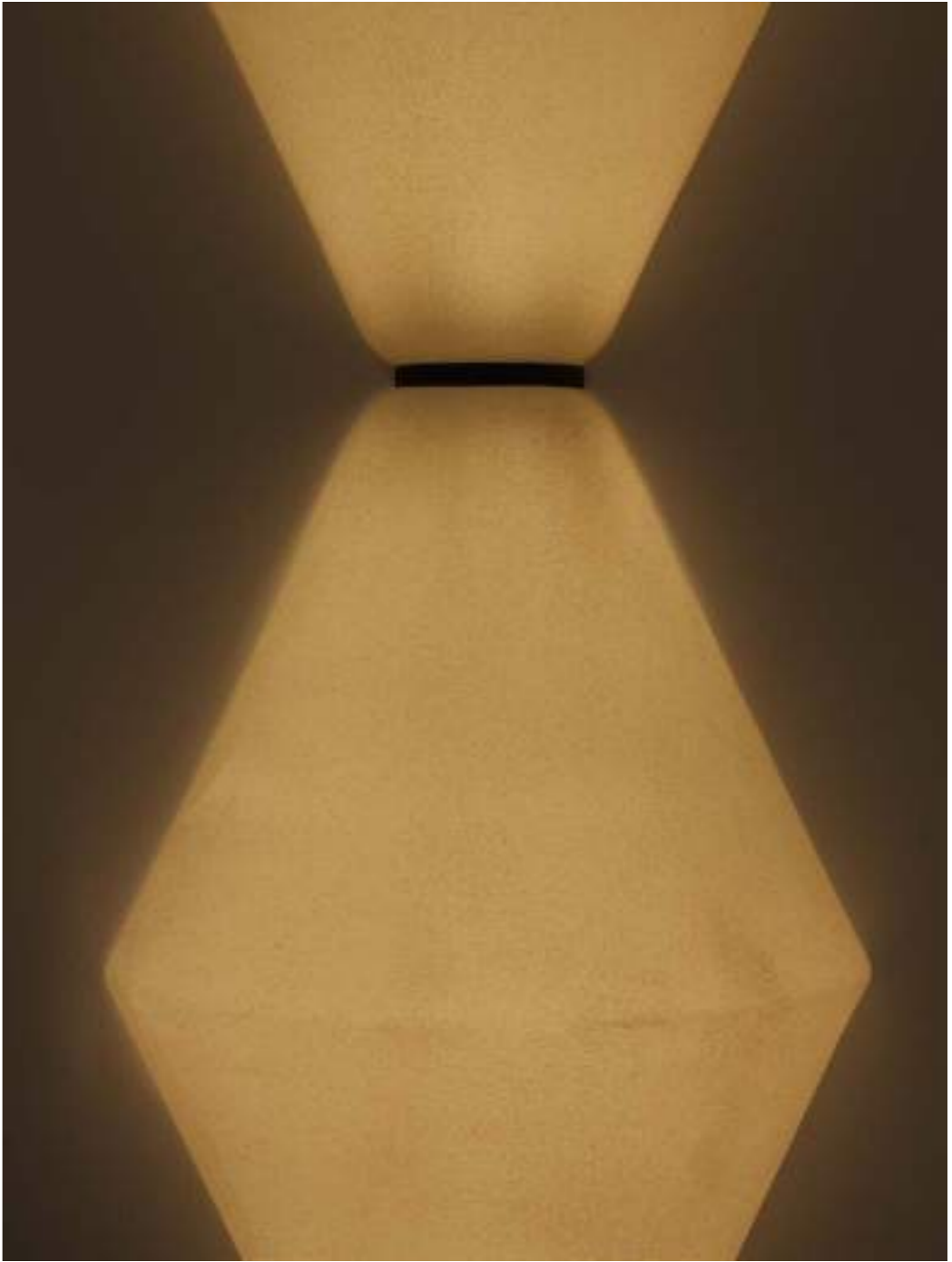



HELIUM  
Elisa Ossino, 2025

IT La materia al servizio della luce. Disegnata da Elisa Ossino per De Padova, Helium è una lampada modulare che gioca con la trasparenza e la rifrazione del vetro lavorato a mano con micro-polvere di sabbia, dalle sfumature eleganti e dall'effetto vellutato. La struttura interna in alluminio garantisce stabilità senza elementi di fissaggio visibili, mentre sottili giunture in nero soft touch ne definiscono il profilo. La luce è diffusa, calda e regolabile tramite dimmer, creando così atmosfere avvolgenti e sofisticate. Helium si presenta versione da terra, sospesa e come applique a muro, sempre modulabile, prestandosi così a composizioni luminose personalizzate, trasformando le pareti in superfici vibranti di luce ed integrandosi perfettamente con l'architettura.

EN Material at the service of light. Designed by Elisa Ossino for De Padova, Helium is a modular lamp that plays with the transparency and refraction of handcrafted glass, treated with fine sand powder to create elegant hues and a velvety finish. Its internal aluminum structure ensures stability with no visible fastenings, while delicate soft-touch black joints define its profile. The light is diffuse, warm, and dimmable, creating an enveloping and sophisticated atmosphere. Helium is also available in floor, pendant and wall-mounted modular versions, offering the possibility of custom lighting compositions that transform walls into vibrant surfaces of light, seamlessly integrating with the surrounding architecture.



Floor/table version

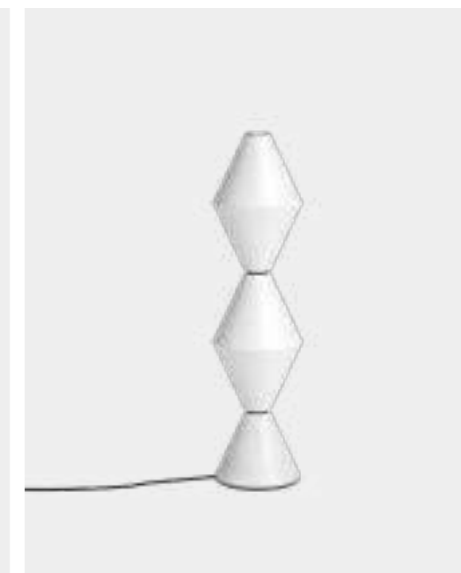

Floor version



Wall version — 1 element



Wall version — 2 elements



Wall version — 3 elements

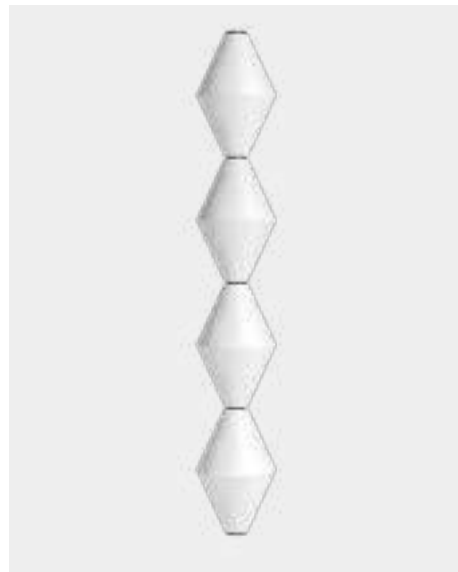

Wall version — 4 elements



Pendant version — 1 element



Pendant version — 2 elements



Pendant version — 3 elements

Floor/table version

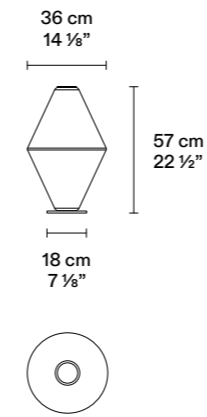

Floor version

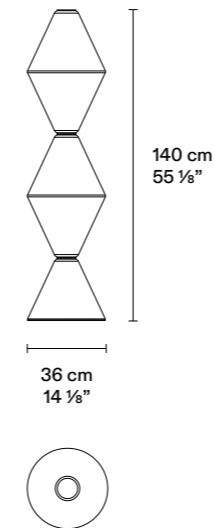



<b>Materiali</b> Materials	Metallo, vetro Metal, glass
<b>Finiture</b> Finishes	Vetro acidato Frosted glass  Vetro "effetto sabbia" "Sand effect" glass
<b>Categoria</b> Category	Da appoggio Floor/table
<b>Specifiche tecniche</b> Technical details	100÷240 V — 50/60 Hz LED 30 W, 24 V, 2700K, CRI94
<b>Controllo</b> Control	Dimmer integrato nel cavo di alimentazione Power cable with integrated dimmer
<b>Certificazioni</b> Certifications	CE

<b>Materiali</b> Materials	Metallo, vetro Metal, glass
<b>Finiture</b> Finishes	Vetro acidato Frosted glass  Vetro "effetto sabbia" "Sand effect" glass
<b>Categoria</b> Category	Da terra Floor
<b>Specifiche tecniche</b> Technical details	EU 220÷240 V — 50/60 Hz LED 80 W, 24 V, 2700K, CRI94  USA 100÷120 V — 50/60 Hz LED 80 W, 24 V, 2700K, CRI94
<b>Controllo</b> Control	Dimmer integrato nel cavo di alimentazione Power cable with integrated dimmer
<b>Certificazioni</b> Certifications	CE

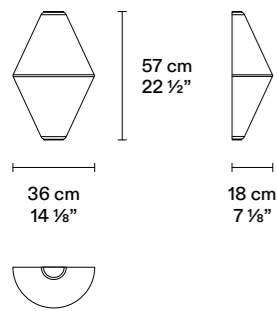

Wall version – 1 element



<b>Materiali</b> Materials	Metallo, vetro Metal, glass
<b>Finiture</b> Finishes	Vetro acidato Frosted glass  Vetro "effetto sabbia" "Sand effect" glass
<b>Categoria</b> Category	Da parete Wall
<b>Specifiche tecniche</b> Technical details	100÷240 V – 50/60 Hz LED 22 W, 24 V, 2700K, CRI95  IP20  
<b>Controllo</b> Control	Dimmer integrato nel corpo della lampada Dimmer integrated in the lamp body (PUSH / 0-10 / DALI / CUT PHASE)
<b>Certificazioni</b> Certifications	

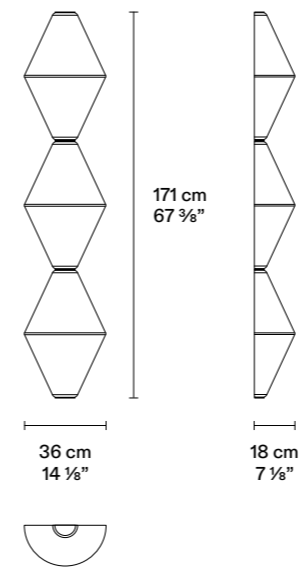

Wall version – 3 elements



<b>Materiali</b> Materials	Metallo, vetro Metal, glass
<b>Finiture</b> Finishes	Vetro acidato Frosted glass  Vetro "effetto sabbia" "Sand effect" glass
<b>Categoria</b> Category	Da parete Wall
<b>Specifiche tecniche</b> Technical details	100÷240 V – 50/60 Hz LED 66 W, 24 V, 2700K, CRI95  IP20  
<b>Controllo</b> Control	Dimmer integrato nel corpo della lampada Dimmer integrated in the lamp body (PUSH / 0-10 / DALI / CUT PHASE)
<b>Certificazioni</b> Certifications	

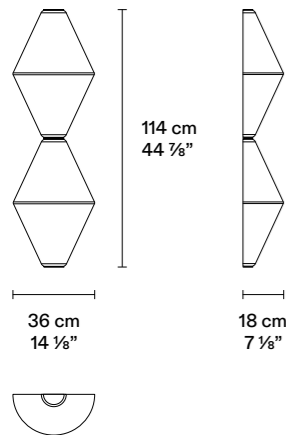

Wall version – 2 elements



<b>Materiali</b> Materials	Metallo, vetro Metal, glass
<b>Finiture</b> Finishes	Vetro acidato Frosted glass  Vetro "effetto sabbia" "Sand effect" glass
<b>Categoria</b> Category	Da parete Wall
<b>Specifiche tecniche</b> Technical details	100÷240 V – 50/60 Hz LED 44 W, 24 V, 2700K, CRI95  IP20  
<b>Controllo</b> Control	Dimmer integrato nel corpo della lampada Dimmer integrated in the lamp body (PUSH / 0-10 / DALI / CUT PHASE)
<b>Certificazioni</b> Certifications	

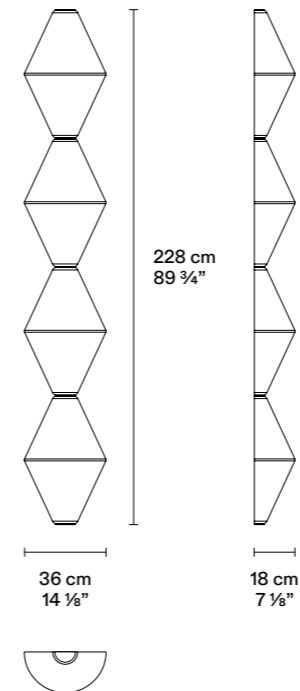

Wall version – 4 elements



<b>Materiali</b> Materials	Metallo, vetro Metal, glass
<b>Finiture</b> Finishes	Vetro acidato Frosted glass  Vetro "effetto sabbia" "Sand effect" glass
<b>Categoria</b> Category	Da parete Wall
<b>Specifiche tecniche</b> Technical details	100÷240 V – 50/60 Hz LED 88 W, 24 V, 2700K, CRI95  IP20  
<b>Controllo</b> Control	Dimmer integrato nel corpo della lampada Dimmer integrated in the lamp body (PUSH / 0-10 / DALI / CUT PHASE)
<b>Certificazioni</b> Certifications	

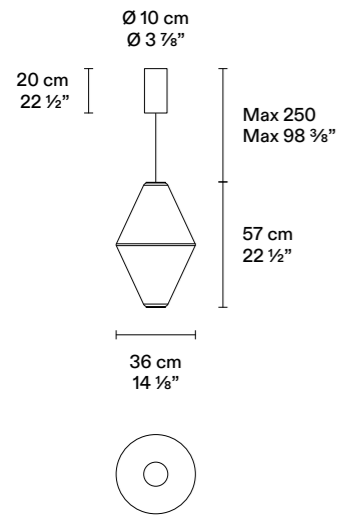

Pendant version – 1 element



<b>Materiali</b> Materials	Metallo, vetro Metal, glass
<b>Finiture</b> Finishes	Vetro acidato Frosted glass  Vetro "effetto sabbia" "Sand effect" glass
<b>Categoria</b> Category	Sospensione Pendant
<b>Specifiche tecniche</b> Technical details	100÷240 V – 50/60 Hz LED 30 W, 24 V, 2700K, CRI94  IP20  
<b>Controllo</b> Control	Dimmer integrato nel rosone Ceiling rose with integrated dimmer (PUSH / 0-10 / DALI / CUT PHASE)
<b>Certificazioni</b> Certifications	

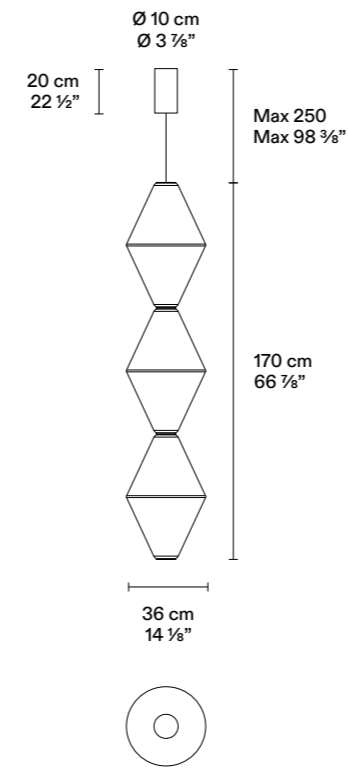

Pendant version – 3 elements

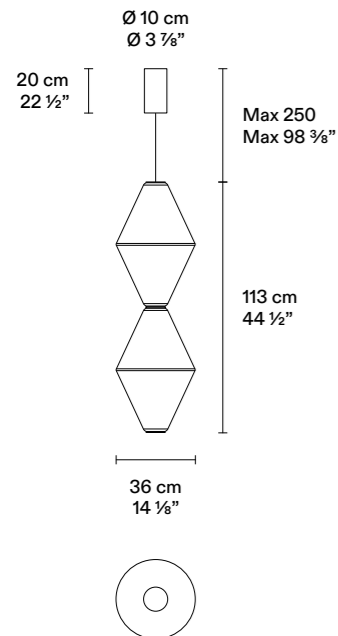

<b>Materiali</b> Materials	Metallo, vetro Metal, glass
<b>Finiture</b> Finishes	Vetro acidato Frosted glass  Vetro "effetto sabbia" "Sand effect" glass
<b>Categoria</b> Category	Sospensione Pendant
<b>Specifiche tecniche</b> Technical details	100÷240 V – 50/60 Hz LED 90 W, 24 V, 2700K, CRI94  IP20  
<b>Controllo</b> Control	Dimmer integrato nel rosone Ceiling rose with integrated dimmer (PUSH / 0-10 / DALI / CUT PHASE)
<b>Certificazioni</b> Certifications	

Pendant version – 2 elements



<b>Materiali</b> Materials	Metallo, vetro Metal, glass
<b>Finiture</b> Finishes	Vetro acidato Frosted glass  Vetro "effetto sabbia" "Sand effect" glass
<b>Categoria</b> Category	Sospensione Pendant
<b>Specifiche tecniche</b> Technical details	100÷240 V – 50/60 Hz LED 60 W, 24 V, 2700K, CRI94  IP20  
<b>Controllo</b> Control	Dimmer integrato nel rosone Ceiling rose with integrated dimmer (PUSH / 0-10 / DALI / CUT PHASE)
<b>Certificazioni</b> Certifications	

HELIUM MINI

Elisa Ossino











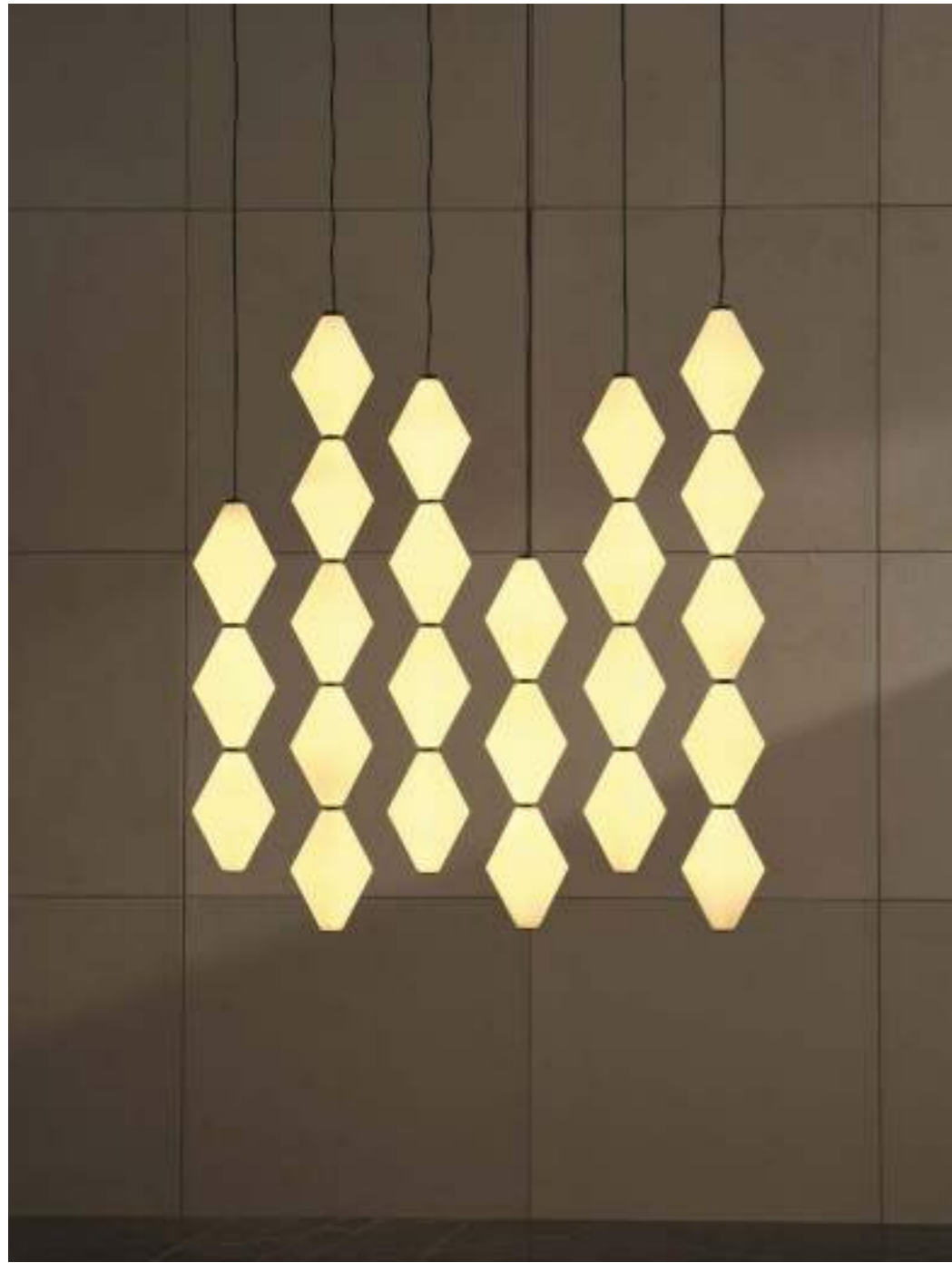









IT La sofisticatezza di Helium in versione Mini. La firma di Elisa Ossino mantiene il gioco di luce grazie alla rifrazione del vetro lavorato a mano con micro-polvere di sabbia, regalando sfumature eleganti e vellutate anche nelle versioni da appoggio, a sospensione con rosone e su binario. Helium Mini si presta sempre a composizioni luminose personalizzate e modulari.

EN The sophistication of Helium, in its Mini version. Elisa Ossino's signature design continues the play of light through the refraction of handcrafted glass treated with fine sand powder, offering elegant, velvety tones in the table, pendant with ceiling rose, and track-mounted versions. Helium Mini remains true to its modular nature, lending itself to personalised lighting compositions.



Table version



Pendant version — 3 elements

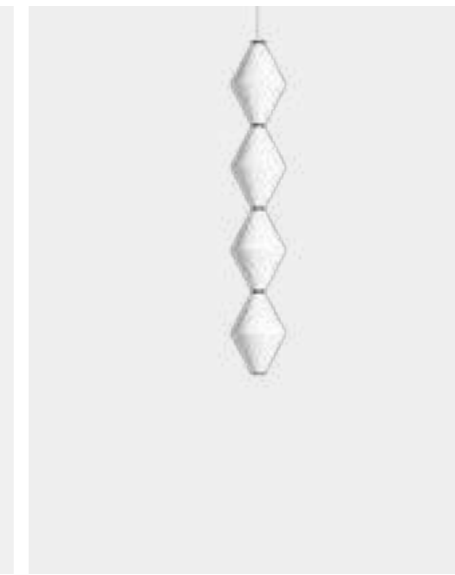

Pendant version — 4 elements

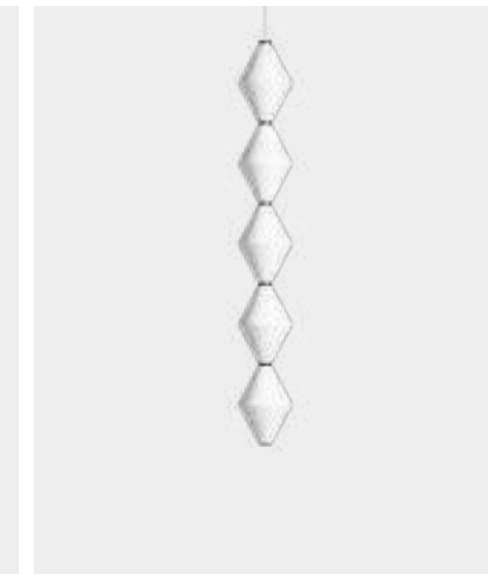

Pendant version — 5 elements



Pendant version — 3+3 elements

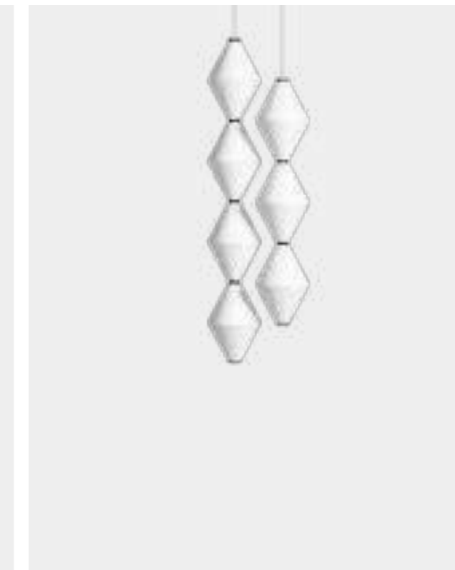

Pendant version — 4+3 elements



Pendant version — 5+3 elements



Pendant version — 4+4 elements

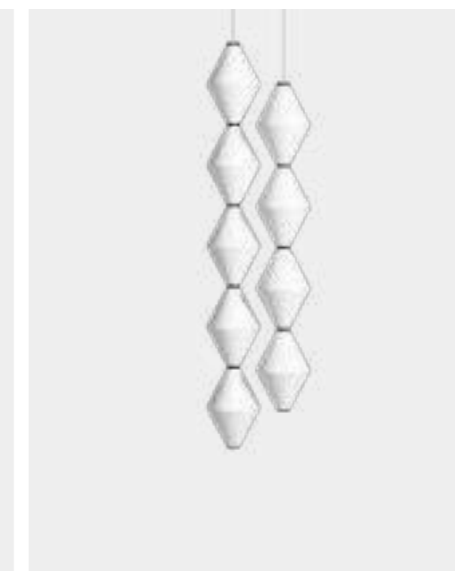



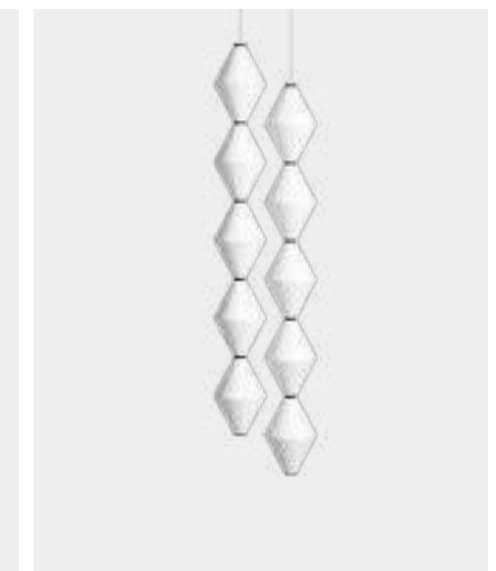

Pendant version — 5+4 elements

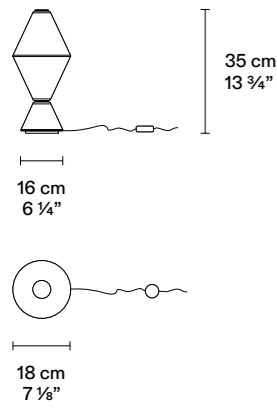

Pendant version — 5+5 elements



Table version



<b>Materiali</b> Materials	Metallo, vetro Metal, glass
<b>Finiture</b> Finishes	Vetro acidato Frosted glass
	Vetro "effetto sabbia" "Sand effect" glass
<b>Categoria</b> Category	Da appoggio Table
<b>Specifiche tecniche</b> Technical details	100÷240 V – 50/60 Hz LED 10 W, 24 V, 2700K, CRI94
	IP20  
<b>Controllo</b> Control	Dimmer integrato nel cavo di alimentazione Power cable with integrated dimmer
<b>Certificazioni</b> Certifications	

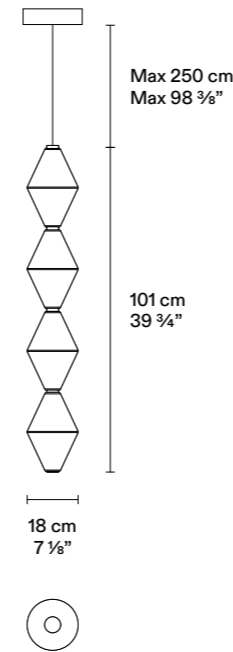

Pendant version – 4 elements



<b>Materiali</b> Materials	Metallo, vetro Metal, glass
<b>Finiture</b> Finishes	Vetro acidato Frosted glass
	Vetro "effetto sabbia" "Sand effect" glass
<b>Categoria</b> Category	Sospensione Pendant
<b>Specifiche tecniche</b> Technical details	100÷240 V – 50/60 Hz LED 29 W, 24 V, 2700K, CRI94
	IP20  
<b>Controllo</b> Control	Dimmer integrato nel rosone Ceiling rose with integrated dimmer (PUSH / 0-10 / DALI / CUT PHASE)
<b>Certificazioni</b> Certifications	

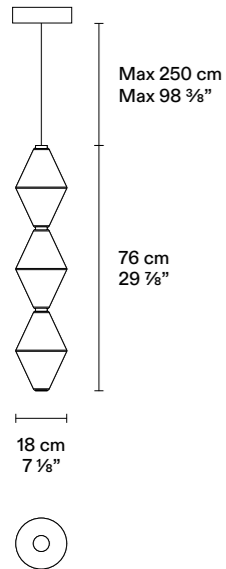

Pendant version – 3 elements

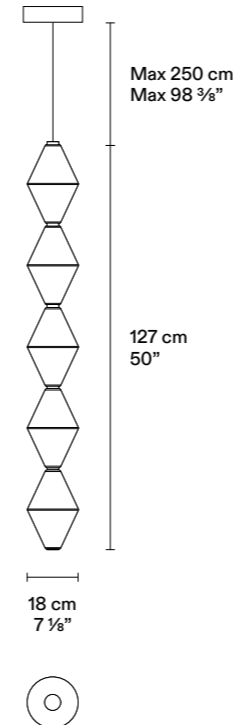

<b>Materiali</b> Materials	Metallo, vetro Metal, glass
<b>Finiture</b> Finishes	Vetro acidato Frosted glass
	Vetro "effetto sabbia" "Sand effect" glass
<b>Categoria</b> Category	Sospensione Pendant
<b>Specifiche tecniche</b> Technical details	100÷240 V – 50/60 Hz LED 20 W, 24 V, 2700K, CRI94
	IP20  
<b>Controllo</b> Control	Dimmer integrato nel rosone Ceiling rose with integrated dimmer (PUSH / 0-10 / DALI / CUT PHASE)
<b>Certificazioni</b> Certifications	

Pendant version – 5 elements



<b>Materiali</b> Materials	Metallo, vetro Metal, glass
<b>Finiture</b> Finishes	Vetro acidato Frosted glass
	Vetro "effetto sabbia" "Sand effect" glass
<b>Categoria</b> Category	Sospensione Pendant
<b>Specifiche tecniche</b> Technical details	100÷240 V – 50/60 Hz LED 36 W, 24 V, 2700K, CRI94
	IP20  
<b>Controllo</b> Control	Dimmer integrato nel rosone Ceiling rose with integrated dimmer (PUSH / 0-10 / DALI / CUT PHASE)
<b>Certificazioni</b> Certifications	

Pendant version – 3+3 elements

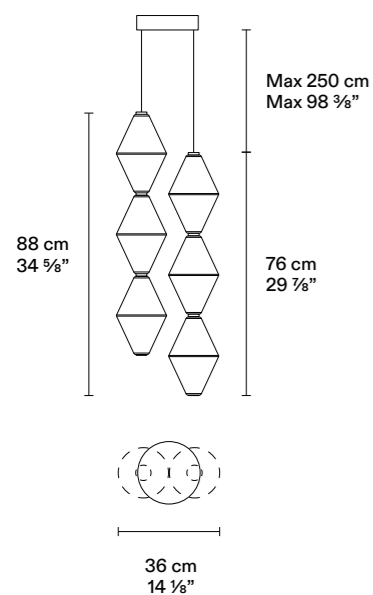

<b>Materiali</b> Materials	Metallo, vetro Metal, glass
<b>Finiture</b> Finishes	Vetro acidato Frosted glass
	Vetro "effetto sabbia" "Sand effect" glass
<b>Categoria</b> Category	Sospensione Pendant
<b>Specifiche tecniche</b> Technical details	100÷240 V – 50/60 Hz LED 40 W, 24 V, 2700K, CRI94
<b>Controllo</b> Control	Dimmer integrato nel rosone Ceiling rose with integrated dimmer (PUSH / 0-10 / DALI / CUT PHASE)
<b>Certificazioni</b> Certifications	CE

Pendant version – 5+3 elements

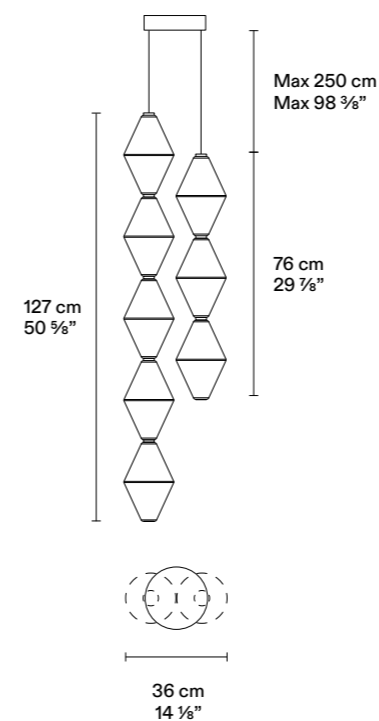

<b>Materiali</b> Materials	Metallo, vetro Metal, glass
<b>Finiture</b> Finishes	Vetro acidato Frosted glass
	Vetro "effetto sabbia" "Sand effect" glass
<b>Categoria</b> Category	Sospensione Pendant
<b>Specifiche tecniche</b> Technical details	100÷240 V – 50/60 Hz LED 30 W, 24 V, 2700K, CRI94
<b>Controllo</b> Control	Dimmer integrato nel rosone Ceiling rose with integrated dimmer (PUSH / 0-10 / DALI / CUT PHASE)
<b>Certificazioni</b> Certifications	CE

Pendant version – 4+3 elements

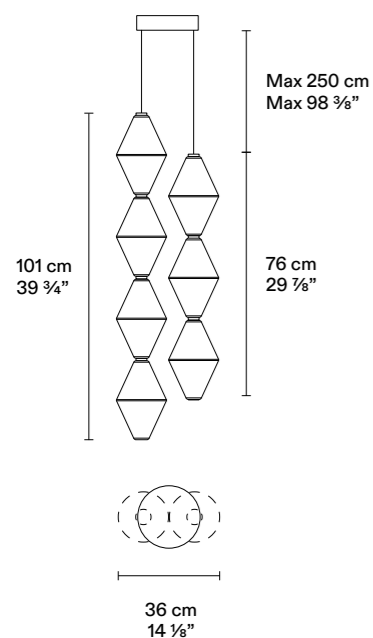

<b>Materiali</b> Materials	Metallo, vetro Metal, glass
<b>Finiture</b> Finishes	Vetro acidato Frosted glass
	Vetro "effetto sabbia" "Sand effect" glass
<b>Categoria</b> Category	Sospensione Pendant
<b>Specifiche tecniche</b> Technical details	100÷240 V – 50/60 Hz LED 49 W, 24 V, 2700K, CRI94
<b>Controllo</b> Control	Dimmer integrato nel rosone Ceiling rose with integrated dimmer (PUSH / 0-10 / DALI / CUT PHASE)
<b>Certificazioni</b> Certifications	CE

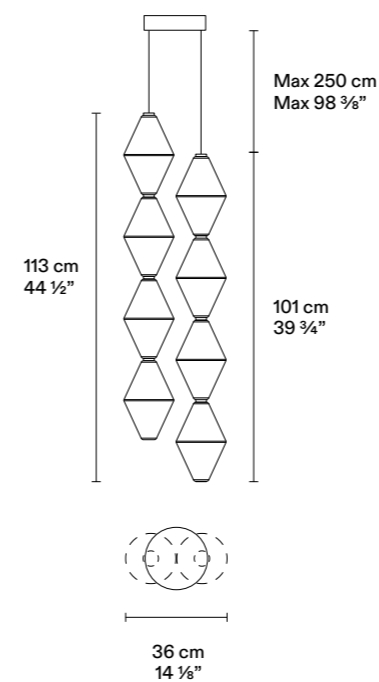

Pendant version – 4+4 elements



<b>Materiali</b> Materials	Metallo, vetro Metal, glass
<b>Finiture</b> Finishes	Vetro acidato Frosted glass
	Vetro "effetto sabbia" "Sand effect" glass
<b>Categoria</b> Category	Sospensione Pendant
<b>Specifiche tecniche</b> Technical details	100÷240 V – 50/60 Hz LED 58 W, 24 V, 2700K, CRI94
<b>Controllo</b> Control	Dimmer integrato nel rosone Ceiling rose with integrated dimmer (PUSH / 0-10 / DALI / CUT PHASE)
<b>Certificazioni</b> Certifications	CE

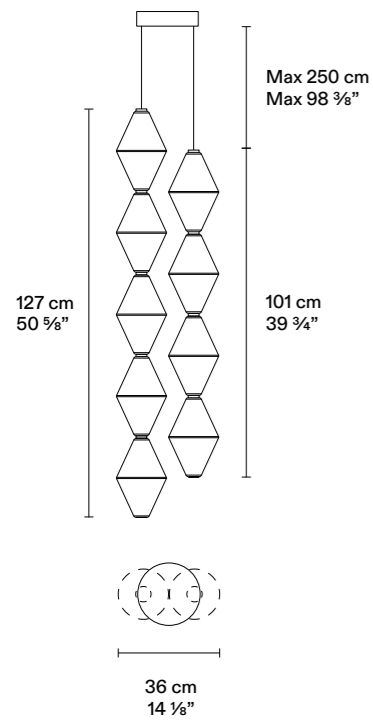

Pendant version – 5+4 elements



<b>Materiali</b> Materials	Metallo, vetro Metal, glass
<b>Finiture</b> Finishes	Vetro acidato Frosted glass
	Vetro "effetto sabbia" "Sand effect" glass
<b>Categoria</b> Category	Sospensione Pendant
<b>Specifiche tecniche</b> Technical details	100÷240 V – 50/60 Hz LED 67 W, 24 V, 2700K, CRI94
	IP20  
<b>Controllo</b> Control	Dimmer integrato nel rosone Ceiling rose with integrated dimmer (PUSH / 0-10 / DALI / CUT PHASE)
<b>Certificazioni</b> Certifications	

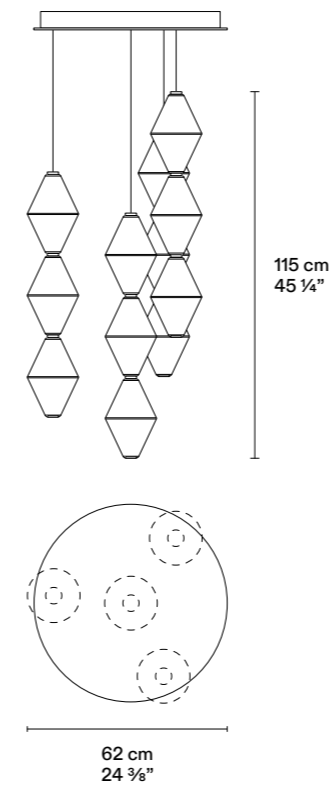

Helium Mini Composition – 12 elements

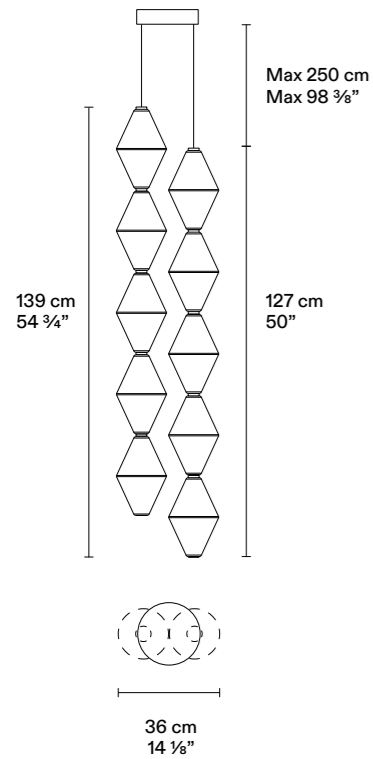

<b>Materiali</b> Materials	Metallo, vetro Metal, glass
<b>Finiture</b> Finishes	Vetro acidato Frosted glass
	Vetro "effetto sabbia" "Sand effect" glass
<b>Categoria</b> Category	Sospensione Pendant
<b>Specifiche tecniche</b> Technical details	100÷240 V – 50/60 Hz LED 80 W, 24 V, 2700K, CRI94
	IP20  
<b>Controllo</b> Control	Dimmer integrato nel rosone Ceiling rose with integrated dimmer (PUSH / 0-10 / DALI / CUT PHASE)
<b>Certificazioni</b> Certifications	

Pendant version – 5+5 elements



<b>Materiali</b> Materials	Metallo, vetro Metal, glass
<b>Finiture</b> Finishes	Vetro acidato Frosted glass
	Vetro "effetto sabbia" "Sand effect" glass
<b>Categoria</b> Category	Sospensione Pendant
<b>Specifiche tecniche</b> Technical details	100÷240 V – 50/60 Hz LED 72 W, 24 V, 2700K, CRI94
	IP20  
<b>Controllo</b> Control	Dimmer integrato nel rosone Ceiling rose with integrated dimmer (PUSH / 0-10 / DALI / CUT PHASE)
<b>Certificazioni</b> Certifications	

Helium Mini Composition – 15 elements

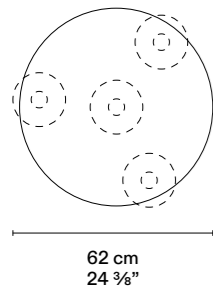
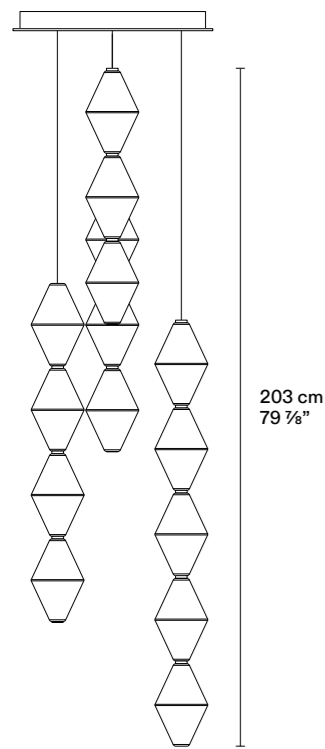

<b>Materiali</b> Materials	Metallo, vetro Metal, glass
<b>Finiture</b> Finishes	Vetro acidato Frosted glass
	Vetro "effetto sabbia" "Sand effect" glass
<b>Categoria</b> Category	Sospensione Pendant
<b>Specifiche tecniche</b> Technical details	100÷240 V – 50/60 Hz LED 105 W, 24 V, 2700K, CRI94
<b>Controllo</b> Control	Dimmer integrato nel rosone Ceiling rose with integrated dimmer (PUSH / 0-10 / DALI / CUT PHASE)
<b>Certificazioni</b> Certifications	CE



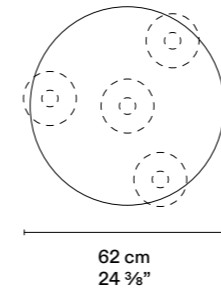
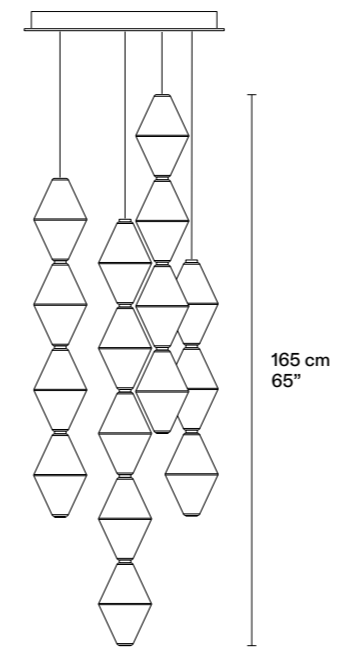

Helium Mini Composition – 16 elements

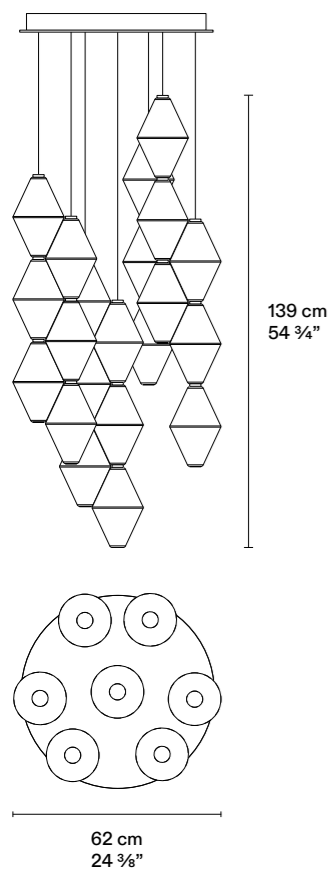

<b>Materiali</b> Materials	Metallo, vetro Metal, glass
<b>Finiture</b> Finishes	Vetro acidato Frosted glass
	Vetro "effetto sabbia" "Sand effect" glass
<b>Categoria</b> Category	Sospensione Pendant
<b>Specifiche tecniche</b> Technical details	100÷240 V – 50/60 Hz LED 114 W, 24 V, 2700K, CRI94
<b>Controllo</b> Control	Dimmer integrato nel rosone Ceiling rose with integrated dimmer (PUSH / 0-10 / DALI / CUT PHASE)
<b>Certificazioni</b> Certifications	CE





Helium Mini Composition – 21 elements

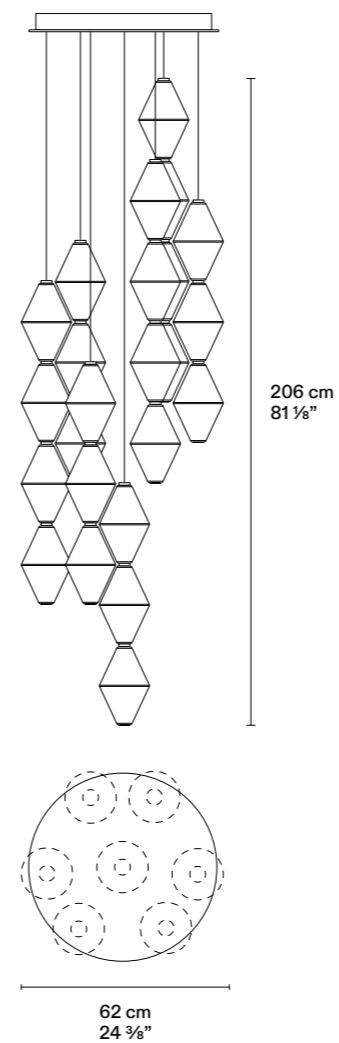

<b>Materiali</b> Materials	Metallo, vetro Metal, glass
<b>Finiture</b> Finishes	Vetro acidato Frosted glass
	Vetro "effetto sabbia" "Sand effect" glass
<b>Categoria</b> Category	Sospensione Pendant
<b>Specifiche tecniche</b> Technical details	100÷240 V – 50/60 Hz LED 140 W, 24 V, 2700K, CRI94
	  
<b>Controllo</b> Control	Dimmer integrato nel rosone Ceiling rose with integrated dimmer (PUSH / 0-10 / DALI / CUT PHASE)
<b>Certificazioni</b> Certifications	

Helium Mini Composition – 24 elements



<b>Materiali</b> Materials	Metallo, vetro Metal, glass
<b>Finiture</b> Finishes	Vetro acidato Frosted glass
	Vetro "effetto sabbia" "Sand effect" glass
<b>Categoria</b> Category	Sospensione Pendant
<b>Specifiche tecniche</b> Technical details	100÷240 V – 50/60 Hz LED 167 W, 24 V, 2700K, CRI94
	  
<b>Controllo</b> Control	Dimmer integrato nel rosone Ceiling rose with integrated dimmer (PUSH / 0-10 / DALI / CUT PHASE)
<b>Certificazioni</b> Certifications	

Helium Mini Composition – 27 elements

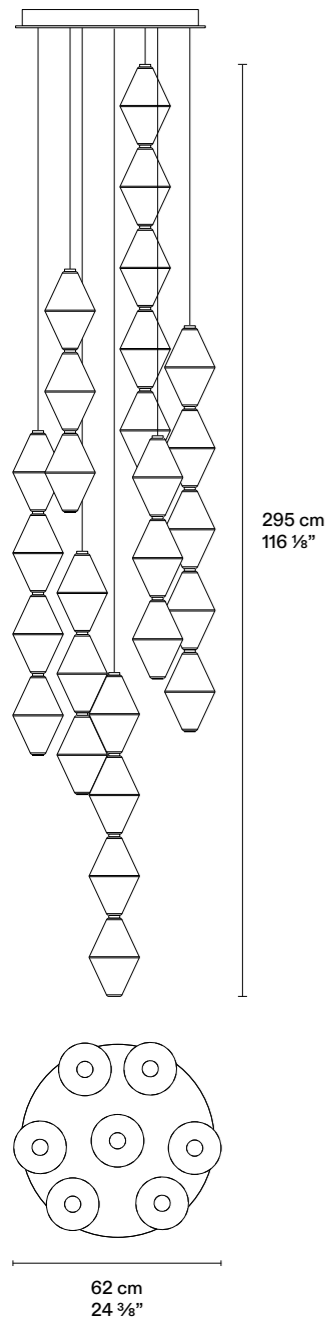

<b>Materiali</b> Materials	Metallo, vetro Metal, glass
<b>Finiture</b> Finishes	Vetro acidato Frosted glass
	Vetro "effetto sabbia" "Sand effect" glass
<b>Categoria</b> Category	Sospensione Pendant
<b>Specifiche tecniche</b> Technical details	100÷240 V – 50/60 Hz LED 190 W, 24 V, 2700K, CRI94
<b>Controllo</b> Control	Dimmer integrato nel rosone Ceiling rose with integrated dimmer (PUSH / 0-10 / DALI / CUT PHASE)
<b>Certificazioni</b> Certifications	CE

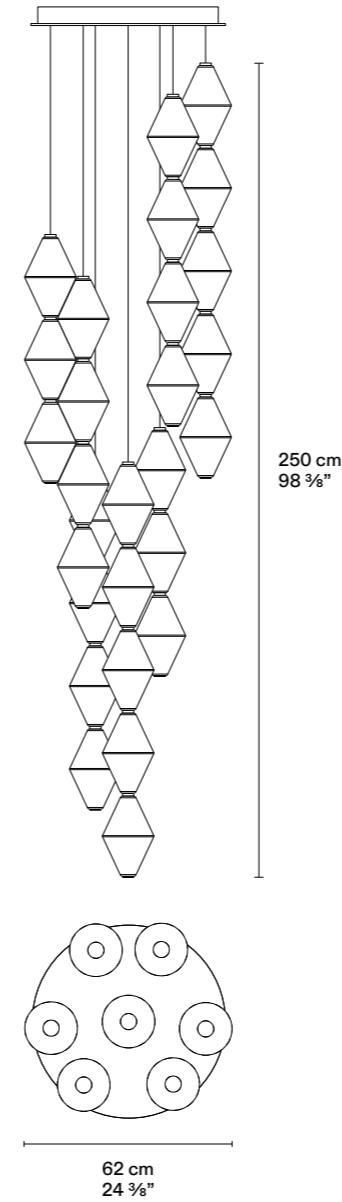

Helium Mini Composition – 28 elements



<b>Materiali</b> Materials	Metallo, vetro Metal, glass
<b>Finiture</b> Finishes	Vetro acidato Frosted glass
	Vetro "effetto sabbia" "Sand effect" glass
<b>Categoria</b> Category	Sospensione Pendant
<b>Specifiche tecniche</b> Technical details	100÷240 V – 50/60 Hz LED 199 W, 24 V, 2700K, CRI94
<b>Controllo</b> Control	Dimmer integrato nel rosone Ceiling rose with integrated dimmer (PUSH / 0-10 / DALI / CUT PHASE)
<b>Certificazioni</b> Certifications	CE

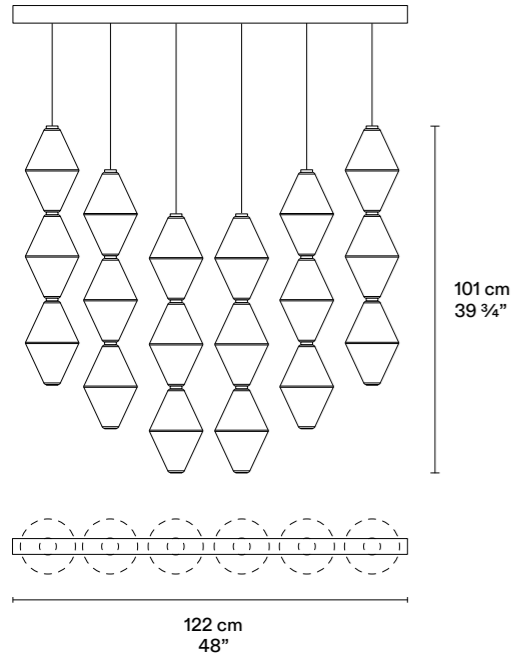

Helium Mini Composition – 18 elements



<b>Materiali</b> Materials	Metallo, vetro Metal, glass
<b>Finiture</b> Finishes	Vetro acidato Frosted glass  Vetro "effetto sabbia" "Sand effect" glass
<b>Categoria</b> Category	Sospensione Pendant
<b>Specifiche tecniche</b> Technical details	100÷240 V – 50/60 Hz LED 120 W, 24 V, 2700K, CRI94  IP20  
<b>Controllo</b> Control	Dimmer integrato nel rosone Ceiling rose with integrated dimmer (PUSH / 0-10 / DALI / CUT PHASE)
<b>Certificazioni</b> Certifications	

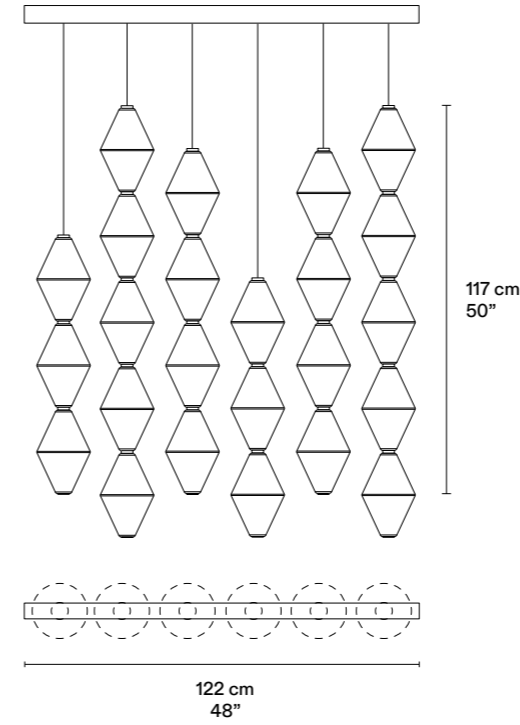

Helium Mini Composition – 24 elements

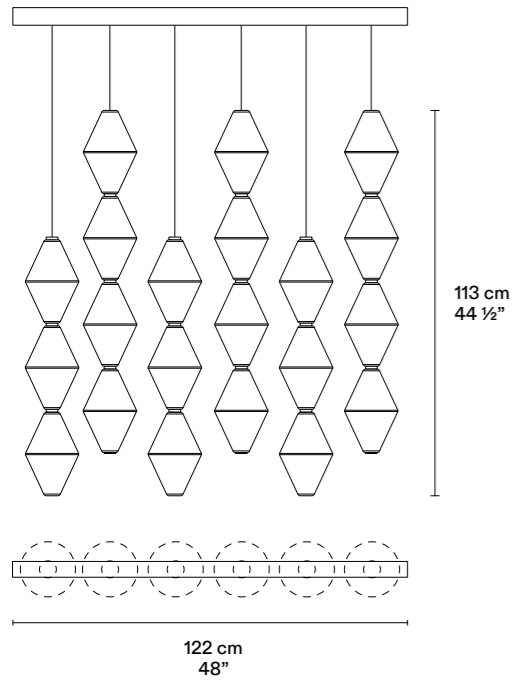

<b>Materiali</b> Materials	Metallo, vetro Metal, glass
<b>Finiture</b> Finishes	Vetro acidato Frosted glass  Vetro "effetto sabbia" "Sand effect" glass
<b>Categoria</b> Category	Sospensione Pendant
<b>Specifiche tecniche</b> Technical details	100÷240 V – 50/60 Hz LED 170 W, 24 V, 2700K, CRI94  IP20  
<b>Controllo</b> Control	Dimmer integrato nel rosone Ceiling rose with integrated dimmer (PUSH / 0-10 / DALI / CUT PHASE)
<b>Certificazioni</b> Certifications	

Helium Mini Composition – 21 elements



<b>Materiali</b> Materials	Metallo, vetro Metal, glass
<b>Finiture</b> Finishes	Vetro acidato Frosted glass  Vetro "effetto sabbia" "Sand effect" glass
<b>Categoria</b> Category	Sospensione Pendant
<b>Specifiche tecniche</b> Technical details	100÷240 V – 50/60 Hz LED 147 W, 24 V, 2700K, CRI94  IP20  
<b>Controllo</b> Control	Dimmer integrato nel rosone Ceiling rose with integrated dimmer (PUSH / 0-10 / DALI / CUT PHASE)
<b>Certificazioni</b> Certifications	

L.O.P.

C.R.S. Boffi







L.O.P.  
C.R.S. Boffi, 2009 / 2012

IT L.O.P è una serie di lampade con corpo in tubolare di alluminio, in diverse varianti di colore, dotate di movimento oscillante e da installare a soffitto in posizione verticale. De Padova prevede il design di L.O.P. con l'aggiunta di una sfera di vetro opaco come terminale del tubo per la diffusione della luce.

EN L.O.P is a series of lamps with a tubular aluminum body, available in different color variants, designed with an oscillating movement and to be ceiling-mounted in a vertical position. De Padova envisions the design of L.O.P. with the addition of a frosted glass sphere at the end of the tube to diffuse the light.



Version without sphere

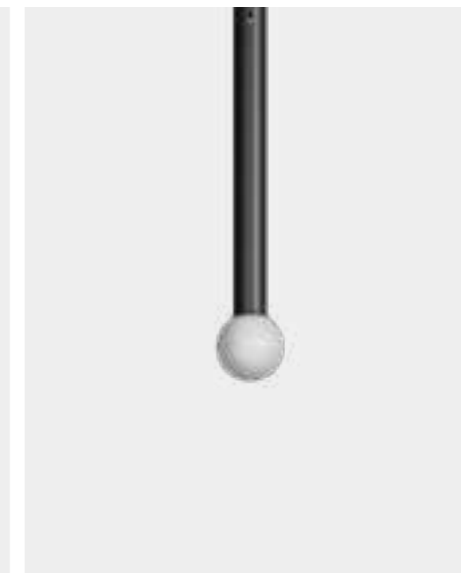

Version with sphere

Version without sphere

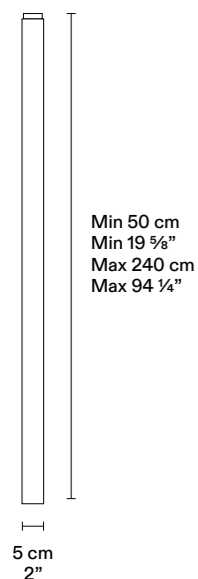

<b>Materiali</b> Materials	Estruso di alluminio anodizzato Anodised extruded aluminium	
<b>Finiture</b> Finishes	Bianco opaco Matt white	
	Nero opaco Matt black	
	Verde Comodoro "soft touch" Comodoro green "soft touch"	
	Rosso Nevada Nevada red	
	Inox Inox	
<b>Categoria</b> Category	Suspension Pendant	
<b>Technical details</b> Specifiche tecniche	100÷240 V – 50/60 Hz LED 7,5 W, 2700K, CRI95 GU10. Max 7,5 W	
<b>Controllo</b> Control	Dimmer non incluso nella lampada Dimmer not included on the lamp	
<b>Certifications</b> Certificazioni		

Ceiling rose

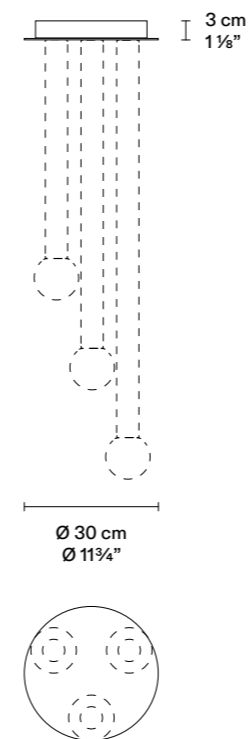

<b>Materiali</b> Materials	Estruso di alluminio anodizzato Anodised extruded aluminium	
<b>Finiture</b> Finishes	Bianco opaco Matt white	
	Nero opaco Matt black	
	Verde Comodoro "soft touch" Comodoro green "soft touch"	
	Rosso Nevada Nevada red	
<b>Categoria</b> Category	Rosone Ceiling rose	

Version with sphere

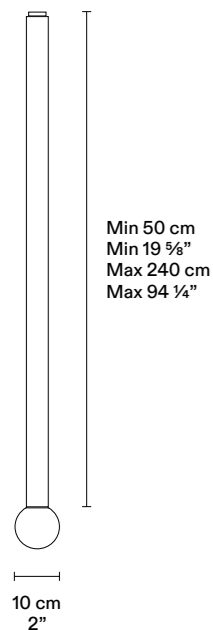

<b>Materiali</b> Materials	Estruso di alluminio anodizzato Anodised extruded aluminium	
<b>Finiture</b> Finishes	Bianco opaco Matt white	
	Nero opaco Matt black	
	Verde Comodoro "soft touch" Comodoro green "soft touch"	
	Rosso Nevada Nevada red	
	Inox Inox	
<b>Categoria</b> Category	Suspension Pendant	
<b>Technical details</b> Specifiche tecniche	EU 100÷240 V – 50/60 Hz LED 7 W, 2700K, CRI95 E27 G95. Max 20 W (included)	
	USA 100÷120 V – 50/60 Hz E26 G95. Max 20 W (not included)	
<b>Controllo</b> Control	Dimmer non incluso nella lampada Dimmer not included on the lamp	
<b>Certifications</b> Certificazioni		

LANTERN

Time & Style édition



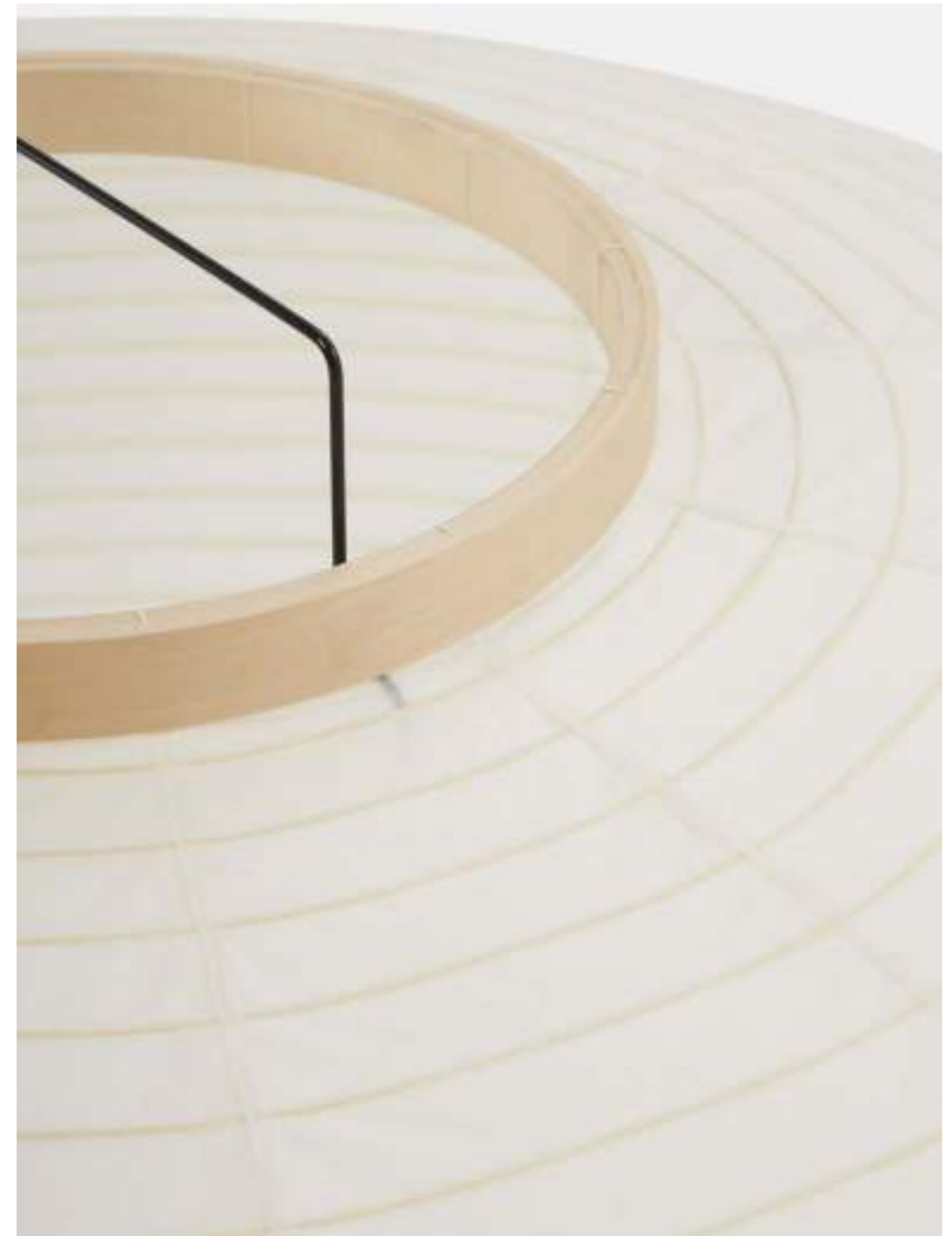

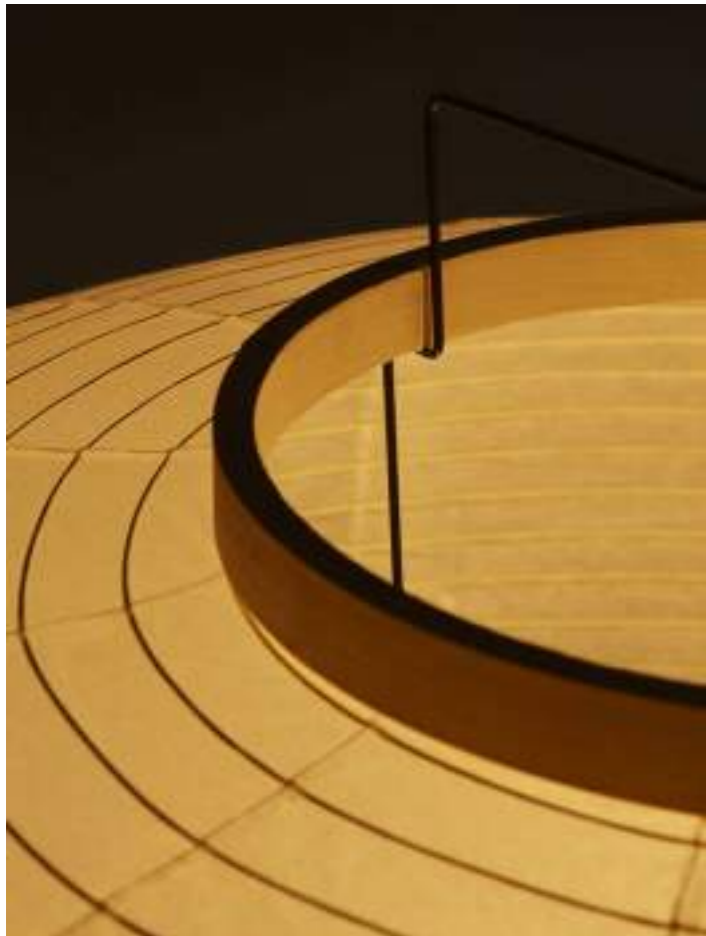

IT Leggera e luminosa, Lantern è una lampada giapponese realizzata in Sekishu washi, una carta pregiata e impalpabile prodotta nella prefettura di Shimane. Tradizione e maestria artigianale si intrecciano nella lavorazione di questa carta, ottenuta da fibre di gelso che le conferiscono resistenza e bellezza. La luce crea così un'atmosfera delicata e avvolgente. La struttura interna presenta una piastra in acciaio inox verniciato, un paralume in carta washi con filo in acciaio rivestito anch'esso in washi e un bordo in tiglio naturale, completato da piedini in acciaio verniciato nero.

EN Lightweight and luminous, Lantern is a Japanese lamp crafted from Sekishu washi, a precious, delicate paper produced in the Shimane prefecture. Tradition and artisanal skill come together in the making of this washi paper, derived from mulberry fibers that lend it both strength and beauty. The light filtered through it creates a soft, enveloping atmosphere. Its internal structure features a painted stainless steel plate, a washi paper shade supported by a steel wire also wrapped in washi, and a natural linden wood rim, finished with black-painted steel feet.

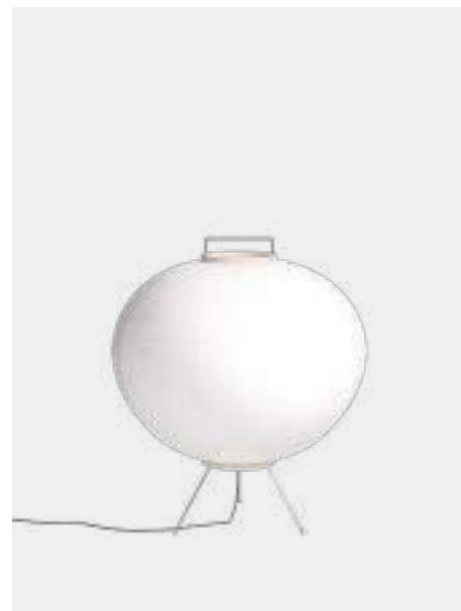

Floor version



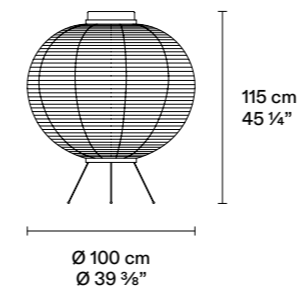

Pendant version



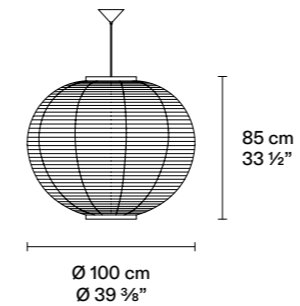

Floor version



Pendant version



<b>Materiali</b> Materials	Acciaio inox, carta giapponese, tiglio naturale Stainless steel, japanese paper, lime wood
<b>Finiture</b> Finishes	Carta giapponese Japanese paper
<b>Categoria</b> Category	Da terra Floor
<b>Specifiche tecniche</b> Technical details	EU 220÷240 V – 50/60 Hz LED E27, max 21 W
	USA 100÷120 V – 50/60 Hz LED E26, max 21 W
	  
<b>Controllo</b> Control	Dimmer integrato nel cavo di alimentazione Power cable with integrated dimmer
<b>Certificazioni</b> Certifications	 

<b>Materiali</b> Materials	Acciaio inox, carta giapponese, tiglio naturale Stainless steel, japanese paper, lime wood
<b>Finiture</b> Finishes	Carta giapponese Japanese paper
<b>Categoria</b> Category	Sospensione Pendant
<b>Specifiche tecniche</b> Technical details	EU 220÷240 V – 50/60 Hz LED E27, max 21 W
	USA 100÷120 V – 50/60 Hz LED E26, max 21 W
	  
<b>Controllo</b> Control	Dimmer non incluso Dimmer not included
<b>Certificazioni</b> Certifications	 

LANTÌA

Elisa Ossino





IT La collezione delle lampade Lantia nasce da un segno elementare e riconoscibile: una sezione trilobata ottenuta dall'intersezione di tre cilindri. Il progetto si ispira agli ordini architettonici a fascio delle antiche colonne, reinterpretati in un sistema d'illuminazione modulare a sviluppo verticale. All'interno, tubi luminosi assemblati con precisione tecnica garantiscono un'emissione continua e uniforme. La luce si diffonde attraverso il vetro soffiato bianco latte acidato; la cannettatura ne amplifica la profondità e genera vibrazioni visive controllate, contribuendo a definire un'atmosfera calda e avvolgente.

EN The Lantia lighting collection originates from an elementary and recognisable sign: a trilobed section obtained from the intersection of three cylinders. The project is inspired by the clustered architectural orders of ancient columns, reinterpreted into a modular, vertically developed lighting system. Inside, luminous tubes assembled with technical precision ensure a continuous and uniform emission. The light diffuses through etched, milk-white blown glass; the ribbed texture enhances its depth and generates controlled visual vibrations, helping to define a warm and enveloping atmosphere.



Floor/table version – H 40 cm



Floor/table version – H 80 cm



Floor/table version – H 120 cm



Floor/table version – H 160 cm



Pendant version – H 40 cm



Pendant version – H 80 cm



Pendant version – H 120 cm



Floor/Pendant version – H 160 cm

Floor/table version – H 40 cm

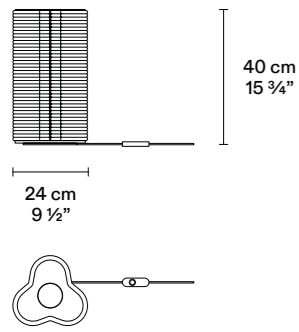

<b>Materiali</b> Materials	Vetro, metallo Glass, metal
<b>Finiture</b> Finishes	Nero opaco "soft touch" Matt black "soft touch"
<b>Categoria</b> Category	Da appoggio Floor/Table
<b>Specifiche tecniche</b> Technical details	100÷240 V – 50/60 Hz LED 20 W, 24 V, 2700K, CRI90
	IP20 □ ▲
<b>Controllo</b> Control	Dimmer integrato nel cavo di alimentazione Power cable with integrated dimmer
<b>Certificazioni</b> Certifications	CE

Floor version – H 120 cm

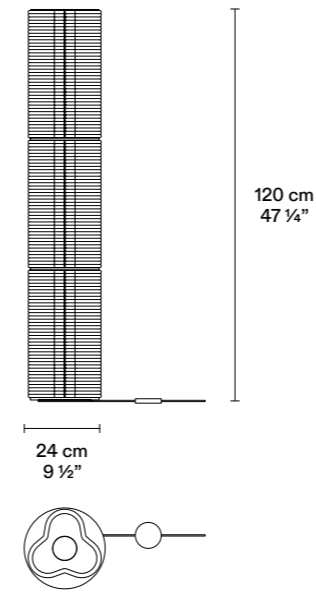

<b>Materiali</b> Materials	Vetro, metallo Glass, metal
<b>Finiture</b> Finishes	Nero opaco "soft touch" Matt black "soft touch"
<b>Categoria</b> Category	Da appoggio Floor
<b>Specifiche tecniche</b> Technical details	100÷240 V – 50/60 Hz LED 60 W, 24 V, 2700K, CRI90
	IP20 □ ▲
<b>Controllo</b> Control	Dimmer integrato nel cavo di alimentazione Power cable with integrated dimmer
<b>Certificazioni</b> Certifications	CE

Floor/table version – H 80 cm

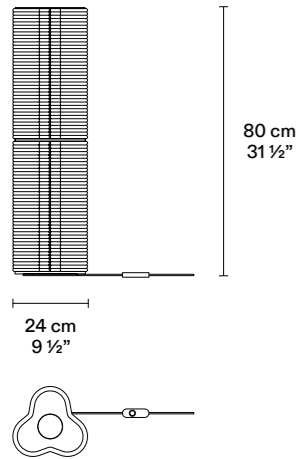

<b>Materiali</b> Materials	Vetro, metallo Glass, metal
<b>Finiture</b> Finishes	Nero opaco "soft touch" Matt black "soft touch"
<b>Categoria</b> Category	Da appoggio Floor/Table
<b>Specifiche tecniche</b> Technical details	100÷240 V – 50/60 Hz LED 40 W, 24 V, 2700K, CRI90
	IP20 □ ▲
<b>Controllo</b> Control	Dimmer integrato nel cavo di alimentazione Power cable with integrated dimmer
<b>Certificazioni</b> Certifications	CE



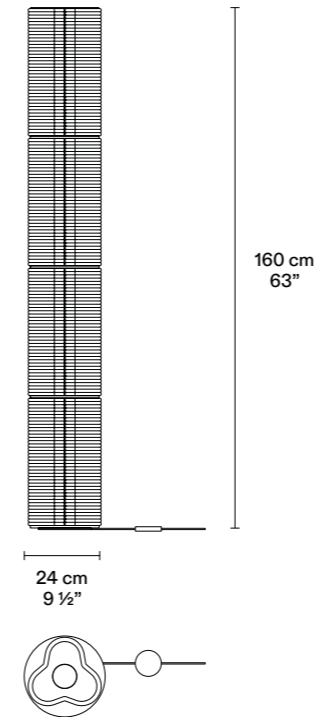

Floor version – H 160 cm

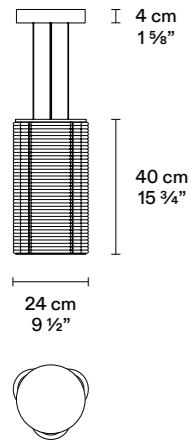

<b>Materiali</b> Materials	Vetro, metallo Glass, metal
<b>Finiture</b> Finishes	Nero opaco "soft touch" Matt black "soft touch"
<b>Categoria</b> Category	Da appoggio Floor
<b>Specifiche tecniche</b> Technical details	100÷240 V – 50/60 Hz LED 80 W, 24 V, 2700K, CRI90
	IP20 □ ▲
<b>Controllo</b> Control	Dimmer integrato nel cavo di alimentazione Power cable with integrated dimmer
<b>Certificazioni</b> Certifications	CE





Pendant version – H 40 cm

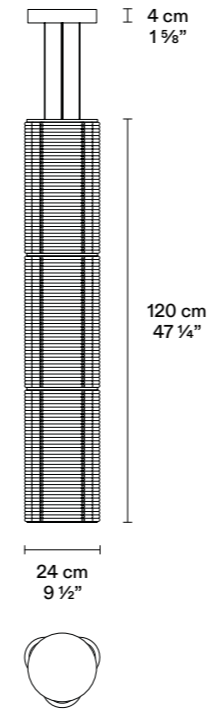

<b>Materiali</b> Materials	Vetro, metallo Glass, metal
<b>Finiture</b> Finishes	Nero opaco "soft touch" Matt black "soft touch"
<b>Categoria</b> Category	Sospensione Pendant
<b>Specifiche tecniche</b> Technical details	100÷240 V – 50/60 Hz LED 20 W, 24 V, 2700K, CRI90
	IP20  
<b>Controllo</b> Control	Dimmer integrato nel rosone Ceiling rose with integrated dimmer (PUSH / 0-10 / DALI / CUT PHASE)
<b>Certificazioni</b> Certifications	 





Pendant version – H 120 cm

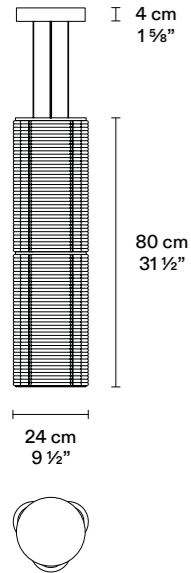

<b>Materiali</b> Materials	Vetro, metallo Glass, metal
<b>Finiture</b> Finishes	Nero opaco "soft touch" Matt black "soft touch"
<b>Categoria</b> Category	Sospensione Pendant
<b>Specifiche tecniche</b> Technical details	100÷240 V – 50/60 Hz LED 60 W, 24 V, 2700K, CRI90
	IP20  
<b>Controllo</b> Control	Dimmer integrato nel rosone Ceiling rose with integrated dimmer (PUSH / 0-10 / DALI / CUT PHASE)
<b>Certificazioni</b> Certifications	 





Pendant version – H 80 cm

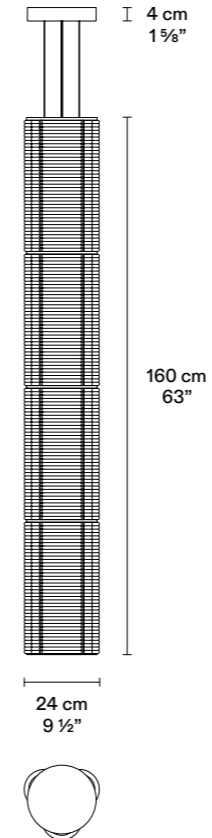

<b>Materiali</b> Materials	Vetro, metallo Glass, metal
<b>Finiture</b> Finishes	Nero opaco "soft touch" Matt black "soft touch"
<b>Categoria</b> Category	Sospensione Pendant
<b>Specifiche tecniche</b> Technical details	100÷240 V – 50/60 Hz LED 40 W, 24 V, 2700K, CRI90
	IP20  
<b>Controllo</b> Control	Dimmer integrato nel rosone Ceiling rose with integrated dimmer (PUSH / 0-10 / DALI / CUT PHASE)
<b>Certificazioni</b> Certifications	 

Pendant version – H 160 cm



<b>Materiali</b> Materials	Vetro, metallo Glass, metal
<b>Finiture</b> Finishes	Nero opaco "soft touch" Matt black "soft touch"
<b>Categoria</b> Category	Sospensione Pendant
<b>Specifiche tecniche</b> Technical details	100÷240 V – 50/60 Hz LED 80 W, 24 V, 2700K, CRI90
	IP20  
<b>Controllo</b> Control	Dimmer integrato nel rosone Ceiling rose with integrated dimmer (PUSH / 0-10 / DALI / CUT PHASE)
<b>Certificazioni</b> Certifications	 

LINEA D'OMBRA

Marco Zanuso Jr





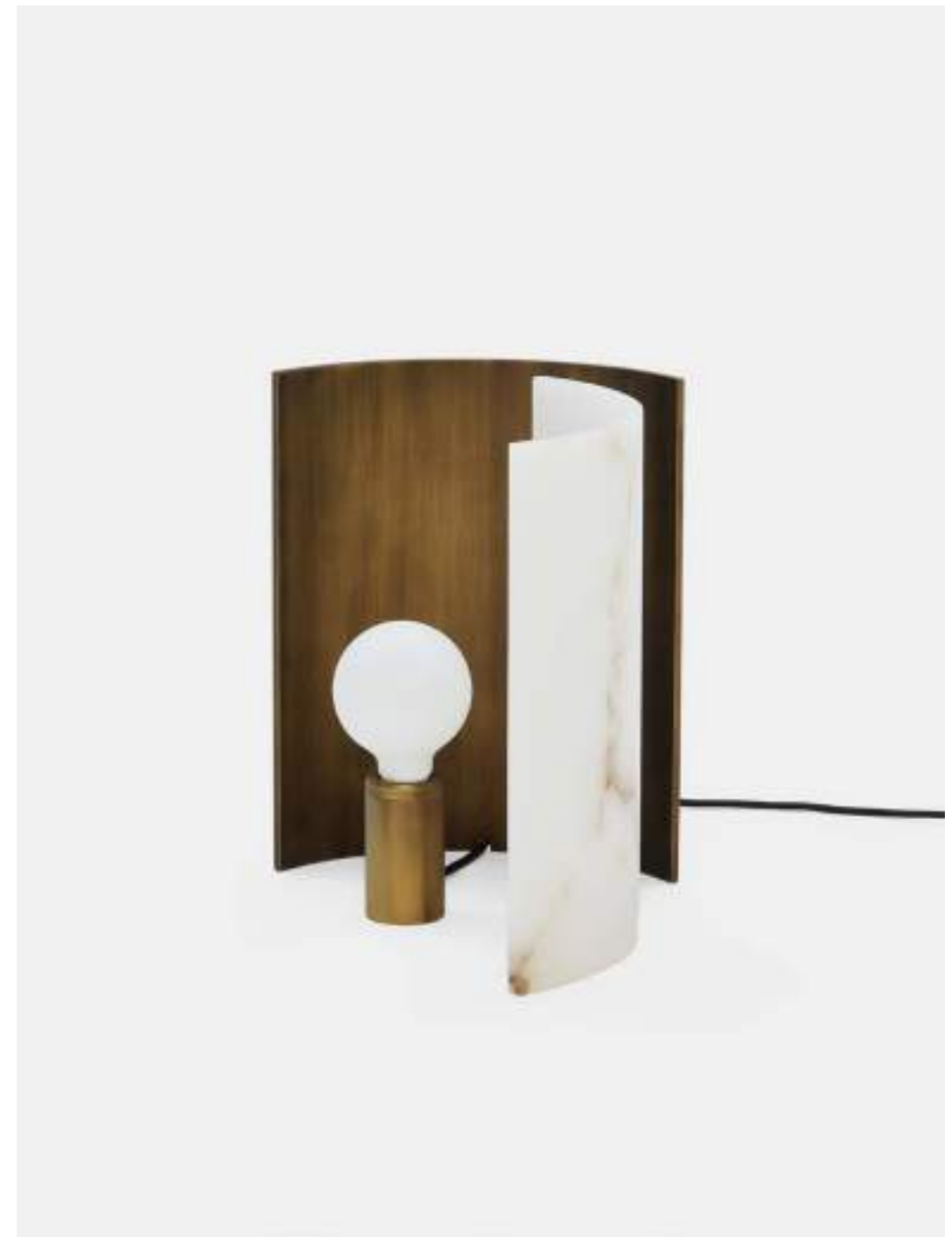

IT La scomposizione dell'ombra. Un gioco di pieni e vuoti disegna questa lampada decostruita e scomposta. La fonte luminosa, appoggiata su un cilindro, è dotata di due pannelli mobili, una in alluminio verniciato color ottone satinato e una in alabastro traslucente che regala eleganti effetti di luce. Queste quinte in materiali diversi, offrono un'alternanza di illuminazione calda e delicata. Infine, il filo in tessuto nero di cotone ha un sistema di dimmerazione che regola l'intensità del corpo illuminante.

EN The deconstruction of shadows. An interplay of solids and voids outlines this deconstructed lamp. A light source rested on a bronze cylinder is equipped with two moving panels, one in satin-finish brass-coloured aluminium and another in translucent alabaster, creating elegant light effects. These backdrops made of different materials offer an alternation of warm and delicate lighting. Lastly, the black cotton thread features a dimming system that adjusts the intensity of the light fixture.

Floor/Table lamp

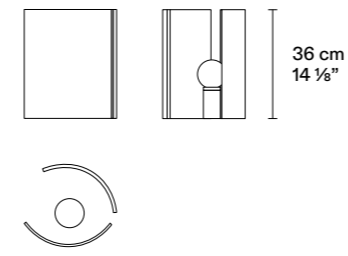

<b>Materiali Materials</b>	Alluminio, alabastro Aluminium, alabaster
<b>Finiture Finishes</b>	Ottone satinato Satin brass  Alabastro Alabaster 
<b>Categoria Category</b>	Appoggio Floor/table
<b>Specifiche tecniche Technical details</b>	EU 220÷240 V – 50/60 Hz LED 7 W, 2700K LED E27 G95, max 20 W USA 100÷120 V – 50/60 Hz LED 7 W, 2700K LED E26 G95, max 20 W   
<b>Controllo Control</b>	Dimmer integrato nel cavo di alimentazione Power cable with integrated dimmer
<b>Certificazioni Certifications</b>	 



Floor/Table lamp

LINEAR LIGHT SYSTEM

C.R.S. De Padova















IT Linear Light System è un sistema luminoso modulare, pensato per offrire ampie possibilità compositive. Il sistema è composto da sottili binari sospesi su tiranti di acciaio nero, su cui è possibile inserire le fonti luminose decorative Nota ed Helium Mini, creando quindi scenari personalizzati e modulabili. Linear Light System permette inoltre di integrare sia dei farette direzionabili per un'illuminazione puntuale e dinamica, sia lampade lineari a LED per un effetto diffuso e uniforme. La libertà progettuale è il punto di forza di Linear Light System in cui ogni elemento può essere combinato trasformando la luce in un vero e proprio strumento di design.

EN Linear Light System is a modular lighting system designed to offer broad creative freedom and multiple configuration possibilities. The system features slim tracks suspended from black steel cables, onto which decorative Technical details such as Nota and Helium Mini can be mounted, allowing for customizable and adaptable lighting scenarios. Linear Light System also supports the integration of adjustable spotlights for focused, dynamic lighting, as well as linear LED modules for diffuse and even illumination. Its strength lies in design flexibility: each element can be freely combined, transforming light into a true tool of design.

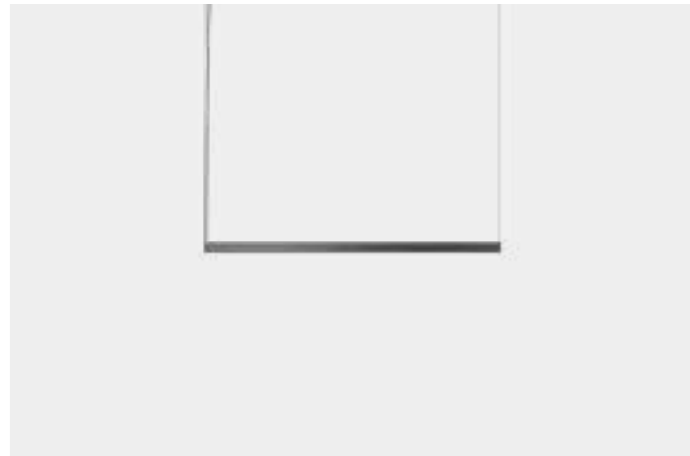

Suspended track - L 100 cm



Suspended track - L 150 cm



Suspended track - L 200 cm



Suspended track - L 300 cm



Spotlight

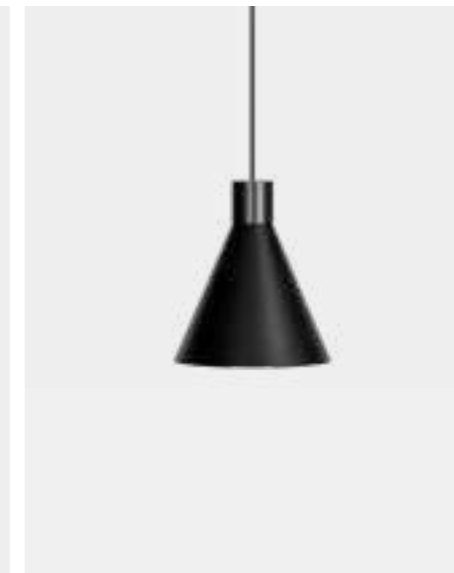

Nota



Helium Mini - 1 element



Helium Mini - 2 elements

Suspended track – L 100/200/300 cm

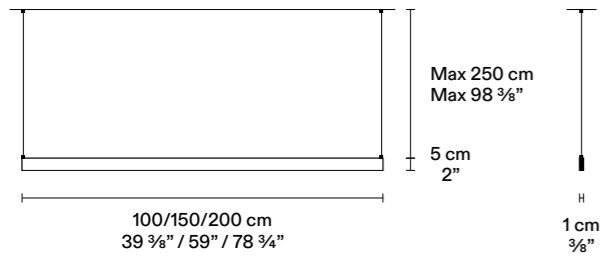

<b>Materiali</b> Materials	Alluminio, metallo Aluminium, steel
<b>Finiture</b> Finishes	Nero opaco "soft touch" Matt black "soft touch"
<b>Categoria</b> Category	Binario sospeso elettrificato a biemissione Pendant bi-emission electrified track
<b>Specifiche tecniche</b> Technical details	IP20
<b>Certificazioni</b> Certifications	

Linear lamp

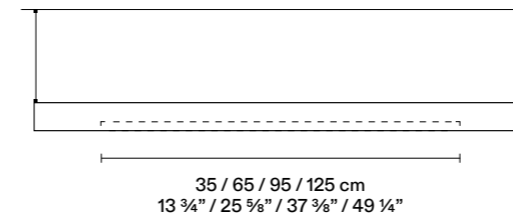

<b>Materiali</b> Materials	Alluminio, metallo Aluminium, steel
<b>Finiture</b> Finishes	Nero opaco "soft touch" Matt black "soft touch"
<b>Categoria</b> Category	Lampada lineare Linear lamp
<b>Specifiche tecniche</b> Technical details	L 35 cm LED 4,5 W, 2700K, CRI90  L 65 cm LED 9 W, 2700K, CRI90  L 95 cm LED 13 W, 2700K, CRI90  L 125 cm LED 17,5 W, 2700K, CRI90  IP20
<b>Controllo</b> Control	Dimmer integrato nel rosone Ceiling rose with integrated dimmer (PUSH / DALI)
<b>Certificazioni</b> Certifications	

Suspended track – L 300 cm

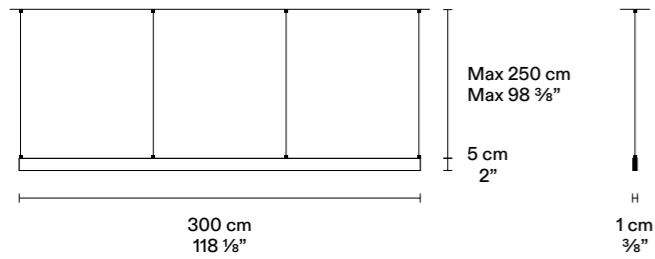

<b>Materiali</b> Materials	Alluminio, metallo Aluminium, steel
<b>Finiture</b> Finishes	Nero opaco "soft touch" Matt black "soft touch"
<b>Categoria</b> Category	Binario sospeso elettrificato a biemissione Pendant bi-emission electrified track
<b>Specifiche tecniche</b> Technical details	IP20
<b>Certificazioni</b> Certifications	



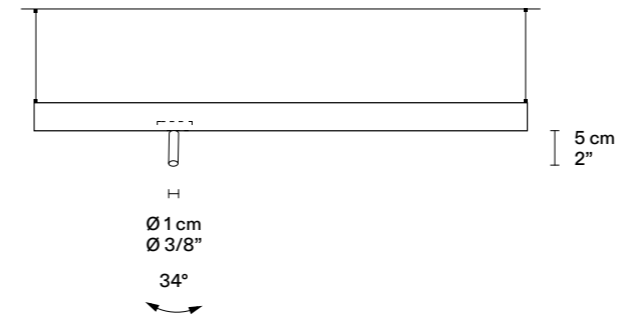

Spotlight

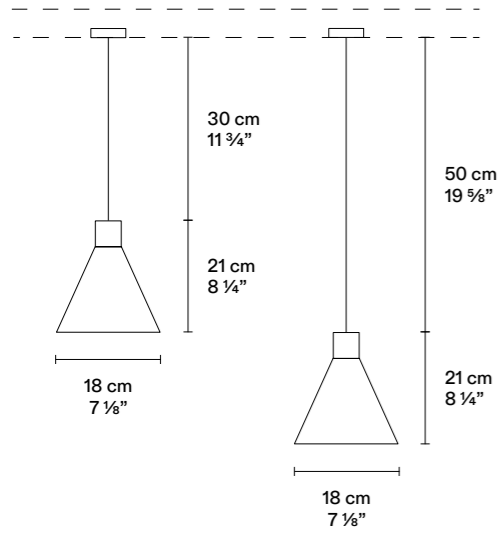

<b>Materiali</b> Materials	Alluminio, metallo Aluminium, steel
<b>Finiture</b> Finishes	Nero opaco "soft touch" Matt black "soft touch"
<b>Categoria</b> Category	Faretto orientabile Adjustable spotlight
<b>Specifiche tecniche</b> Technical details	LED 2 W, 2700K, CRI90  IP20
<b>Controllo</b> Control	Dimmer integrato nel rosone Ceiling rose with integrated dimmer (PUSH / DALI)
<b>Certificazioni</b> Certifications	







Nota

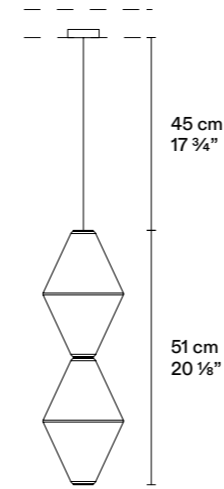

<b>Materiali</b> Materials	Alluminio, metallo Aluminium, steel
<b>Finiture</b> Finishes	Nero opaco "soft touch" Matt black "soft touch" 
<b>Categoria</b> Category	Lampada a sospensione Pendant lamp
<b>Specifiche tecniche</b> Technical details	100÷240V - 50/60Hz LED 8W, 24V, 2700K, CRI90
<b>Certificazioni</b> Certifications	   







Helium Mini - 2 elements

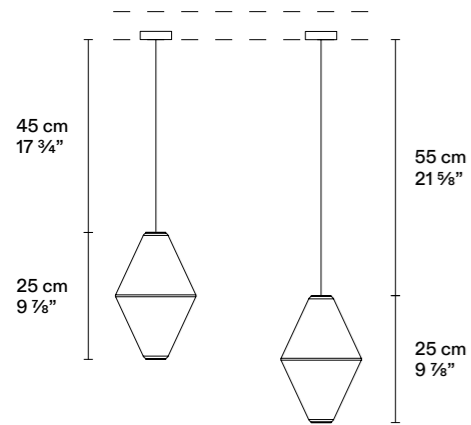

<b>Materiali</b> Materials	Alluminio, metallo Aluminium, steel
<b>Finiture</b> Finishes	Vetro acidato Frosted glass  Vetro decorato "effetto sabbia" "Sand effect" glass 
<b>Categoria</b> Category	Lampada a sospensione Pendant lamp
<b>Specifiche tecniche</b> Technical details	100÷240 V - 50/60 Hz LED 13 W, 24 V, 2700K, CRI94
<b>Certificazioni</b> Certifications	   

Helium Mini - 1 element



<b>Materiali</b> Materials	Alluminio, metallo Aluminium, steel
<b>Finiture</b> Finishes	Vetro acidato Frosted glass  Vetro decorato "effetto sabbia" "Sand effect" glass 
<b>Categoria</b> Category	Lampada a sospensione Pendant lamp
<b>Specifiche tecniche</b> Technical details	100÷240 V - 50/60 Hz LED 6 W, 24 V, 2700K, CRI94
<b>Certificazioni</b> Certifications	   

MOGURA

Nendo









IT Mogura unisce il tratto lineare del designer giapponese Nendo con il significato intrinseco del nome: Mogura significa "talpa", e questa lampada, da terra o da sospensione, stilizza il segno grafico del solco nel terreno che si inserisce nella linea della struttura. Quasi una voliera, in acciaio verniciato nero opaco, declinata in diverse circonferenze.

EN Mogura combines the linear style of Japanese designer Nendo with the intrinsic meaning of its name: Mogura means "mole", and this lamp—available as a floor or pendant version—stylizes the graphic sign of a furrow in the ground, seamlessly integrated into the structure's design. Almost like an aviary, it is made of black matte-painted steel and comes in various diameters.



Floor version — Ø 37 cm



Floor version — Ø 52 cm

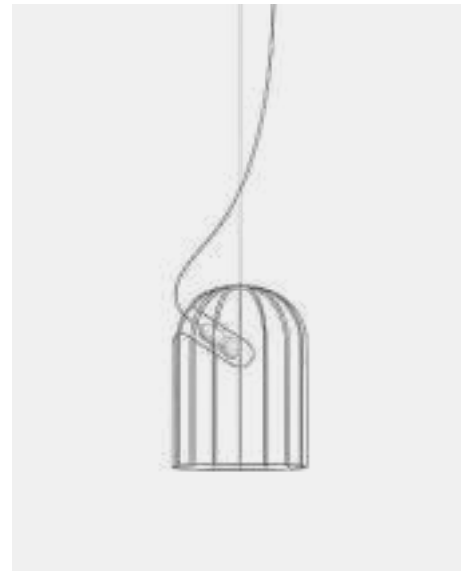

Pendant version — Ø 37 cm



Pendant version — Ø 52 cm



Pendant version — Ø 90 cm

Floor version — Ø 37 cm

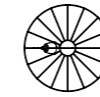
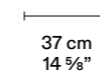
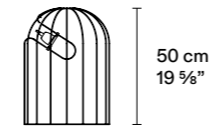

Floor version — Ø 52 cm

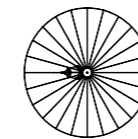
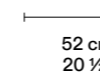

<b>Materiali</b> Materials	Acciaio, ceramica, metacrilato Steel, ceramic, methacrylate
<b>Finiture</b> Finishes	Nero Black
<b>Categoria</b> Category	Da terra Floor
<b>Specifiche tecniche</b> Technical details	EU 220÷240 V — 50/60 Hz LED E27, max 7 W  USA 100÷120 V — 50/60 Hz LED E26, max 7 W
<b>Controllo</b> Control	Dimmer non incluso nella lampada Dimmer not integrated on the lamp
<b>Certificazioni</b> Certifications	CE

<b>Materiali</b> Materials	Acciaio, ceramica, metacrilato Steel, ceramic, methacrylate
<b>Finiture</b> Finishes	Nero Black
<b>Categoria</b> Category	Da terra Floor
<b>Specifiche tecniche</b> Technical details	EU 220÷240 V — 50/60 Hz LED E27, max 7 W  USA 100÷120 V — 50/60 Hz LED E26, max 7 W
<b>Controllo</b> Control	Dimmer non incluso nella lampada Dimmer not integrated on the lamp
<b>Certificazioni</b> Certifications	CE

Pendant version – Ø 37 cm

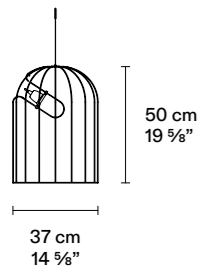

<b>Materiali Materials</b>	Acciaio, ceramica, metacrilato Steel, ceramic, methacrylate
<b>Finiture Finishes</b>	Nero Black
<b>Categoria Category</b>	Sospensione Pendant
<b>Specifiche tecniche Technical details</b>	EU 220÷240 V – 50/60 Hz LED E27 W, max 7 W  USA 100÷120 V – 50/60 Hz LED E26, max 7 W
<b>Controllo Control</b>	Dimmer non incluso nella lampada Dimmer not integrated on the lamp
<b>Certificazioni Certifications</b>	CE

Pendant version – Ø 90 cm

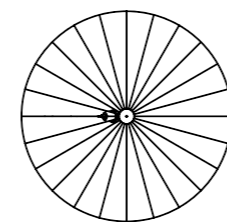
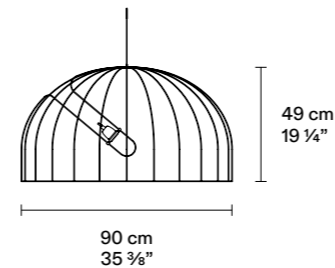

<b>Materiali Materials</b>	Acciaio, ceramica, metacrilato Steel, ceramic, methacrylate
<b>Finiture Finishes</b>	Nero Black
<b>Categoria Category</b>	Sospensione Pendant
<b>Specifiche tecniche Technical details</b>	EU 220÷240 V – 50/60 Hz LED E27W, max 7 W  USA 100÷120 V – 50/60 Hz LED E26, max 7 W
<b>Controllo Control</b>	Dimmer non incluso nella lampada Dimmer not integrated on the lamp
<b>Certificazioni Certifications</b>	CE

Pendant version – Ø 52 cm

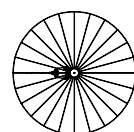
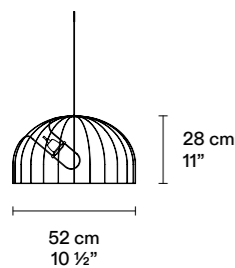

<b>Materiali Materials</b>	Acciaio, ceramica, metacrilato Steel, ceramic, methacrylate
<b>Finiture Finishes</b>	Nero Black
<b>Categoria Category</b>	Sospensione Pendant
<b>Specifiche tecniche Technical details</b>	EU 220÷240 V – 50/60 Hz LED E27 W, max 7 W  USA 100÷120 V – 50/60 Hz LED E26, max 7 W
<b>Controllo Control</b>	Dimmer non incluso nella lampada Dimmer not integrated on the lamp
<b>Certificazioni Certifications</b>	CE

NAGOYA

Time & Style *ē*dition











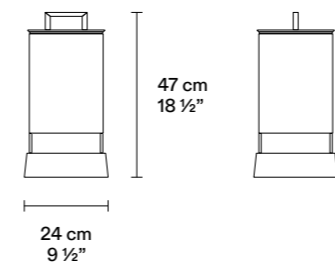

IT Nagoya si ispira alle lampade da terra giapponesi del periodo Edo, reinterpretando la tradizione con un design essenziale. È realizzata in cedro Akita, un legno pregiato che non si deforma né si crepa, abbinato a carta washi fatta a mano. Frutto di ricerche su testi storici e manufatti antichi, questa lampada da terra o da appoggio è un capolavoro di luce e materia, assemblato artigianalmente senza parti metalliche attraverso raffinati incastri in legno.

EN Nagoya draws inspiration from Japanese floor lamps of the Edo period, reinterpreting tradition with a clean, essential design. It is crafted from Akita cedar, a prized wood that resists warping and cracking, paired with handmade washi paper. The result of in-depth research into historical texts and antique objects, this floor or table lamp is a masterpiece of light and material, handcrafted without metal parts using refined wooden joints.

Floor/Table lamp



<b>Materiali</b> <b>Materials</b>	Legno massello, carta giapponese Solid wood, Japanese paper
<b>Finiture</b> <b>Finishes</b>	Cedro Cedarwood  Carta giapponese Japanese paper
<b>Categoria</b> <b>Category</b>	Da appoggio Floor/table
<b>Specifiche tecniche</b> <b>Technical details</b>	EU 220÷240 V – 50/60 Hz LED G9, max 4 W  USA 100÷120 V – 50/60 Hz LED G9, max 4 W
	  
<b>Controllo</b> <b>Control</b>	Dimmer integrato Dimmer integrated
<b>Certificazioni</b> <b>Certifications</b>	



Floor/Table lamp

NAVIGLIO

Piero Lissoni









NAVIGLIO  
Piero Lissoni, 1995

IT Naviglio è una lampada a sospensione che si apre in un paralume delineato da forme semisferiche e realizzato in alluminio tornito a piastra. Espressione concreta della luce, ritmata dal tratto moderno e deciso di Piero Lissoni. Naviglio è una lampada dall'appeal moderno, disponibile nella versione verniciata, panna o nero, e nelle nuove varianti colore rosso Nevada e verde Comodoro.

EN Naviglio is a pendant lamp that opens into a shade defined by hemispherical shapes and crafted from turned plate aluminium. A tangible expression of light, it is marked by the modern, assertive style of Piero Lissoni. Naviglio is a lamp with a contemporary appeal, available in painted finishes—cream or black—and in the new Nevada red and Comodoro green colour variants.

Pendant lamp

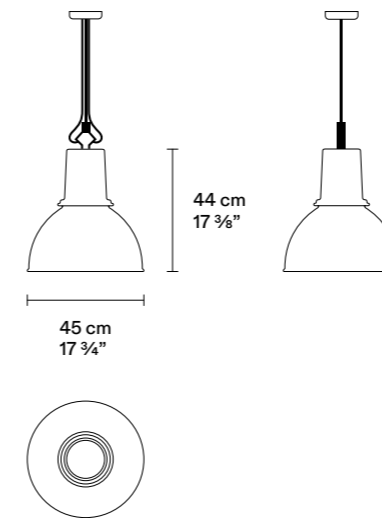

<b>Materiali</b> Materials	Alluminio Aluminium
<b>Finiture</b> Finishes	Panna Cream
	Nero Black
	Verde comodoro "soft touch" Comodoro green "soft touch"
	Rosso Nevada Nevada red
<b>Categoria</b> Category	Sospensione Pendant
<b>Specifiche tecniche</b> Technical details	EU 220÷240 V – 50/60 Hz LED E27, max 21 W
	USA 100÷120 V – 50/60 Hz LED E26, max 21 W
<b>Controllo</b> Control	Dimmer non incluso nella lampada Dimmer not integrated on the lamp
<b>Certificazioni</b> Certifications	



Pendant lamp

NOTA

Elisa Ossino





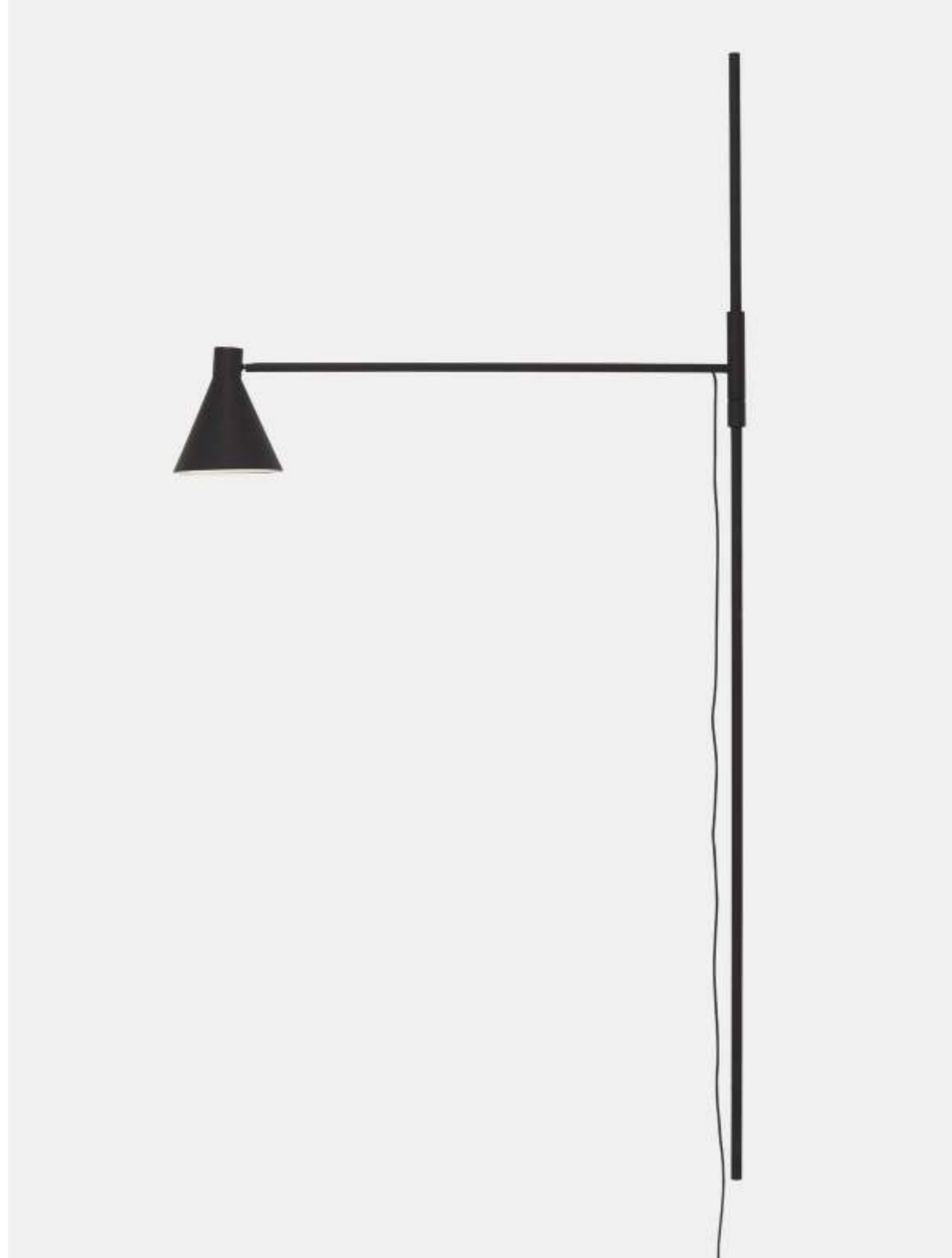

NOTA  
Elisa Ossino, 2017

IT La linea grafica è quella gentile e armonica di Elisa Ossino. Nota, infatti, è la lampada dal segno poetico e allo stesso tempo funzionale, con i due tavolini sullo stelo, nel modello da terra, per appoggiare un libro o una tazza di tè. La sorgente luminosa si può orientare dove serve, lasciando che il cono di luce apra a interpretazioni personali dello spazio, anche come lampada da parete, misurando la luce con il suo minimalismo.

EN The graphic line is the gentle, harmonious one of Elisa Ossino. Nota is a lamp with a poetic yet functional design, featuring two small tables on the stem in the floor model—perfect for resting a book or a cup of tea. The light source can be directed where needed, allowing the cone of light to invite personal interpretations of space. It also works as a wall lamp, measuring light through its minimalist presence.



Floor version - Lamp arm L 60 cm



Floor version - Lamp arm L 100 cm

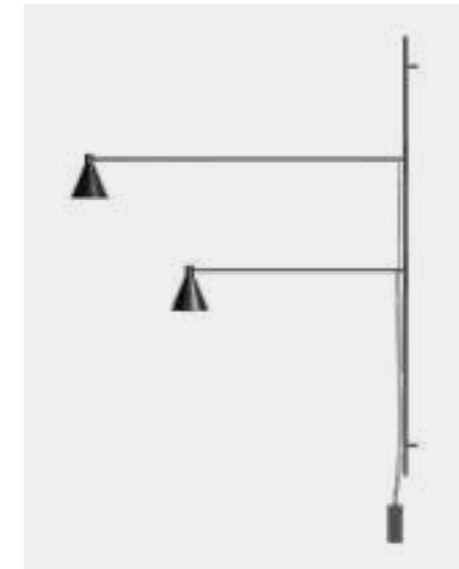

Wall version - Two lamp arms

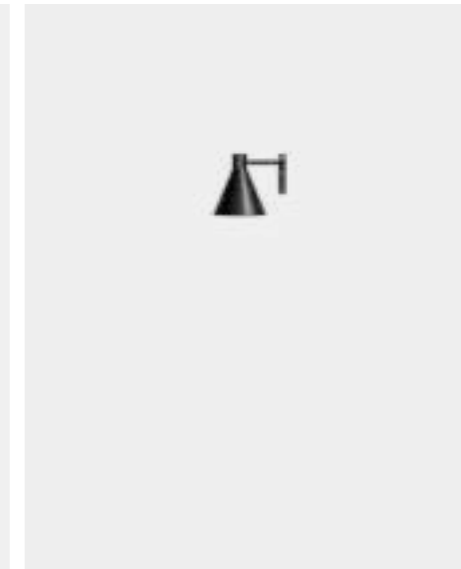

Wall version

Floor version - Lamp arm L 60 cm

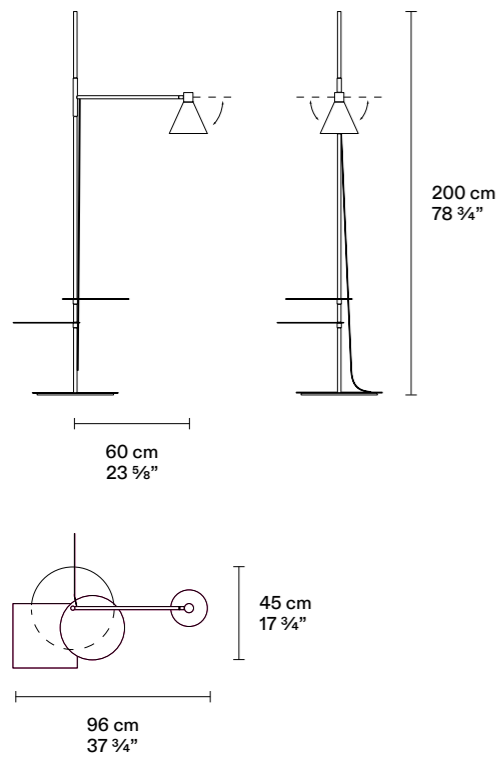

<b>Materiali</b> Materials	Acciaio, PVC elastico Steel, elastic PVC
<b>Finiture</b> Finishes	Nero opaco "soft touch" Matt black "soft touch"
<b>Categoria</b> Category	Da terra Floor
<b>Technical details</b> Specifiche tecniche	100÷240 V – 50/60 Hz 1x LED 8 W, 24 V, 2700K, CRI90
	IP20 □ ▲
<b>Controllo</b> Control	Dimmer integrato sul paralume Integrated dimmer on the lampshade
<b>Certifications</b> Certificazioni	CE

Wall version - Two lamp arms

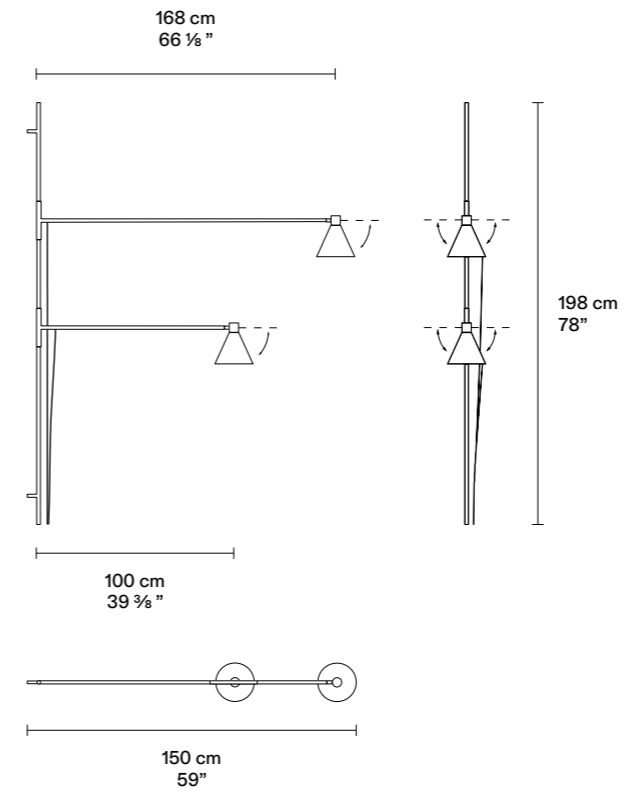

<b>Materiali</b> Materials	Acciaio, PVC elastico Steel, elastic PVC
<b>Finiture</b> Finishes	Nero opaco "soft touch" Matt black "soft touch"
<b>Categoria</b> Category	Da parete Wall
<b>Technical details</b> Specifiche tecniche	100÷240 V – 50/60 Hz 2 x LED 8 W, 24 V, 2700K, CRI90
	IP20 □ ▲
<b>Controllo</b> Control	Dimmer integrato sul paralume Integrated dimmer on the lampshade
<b>Certifications</b> Certificazioni	CE

Floor version - Lamp arm L 100 cm

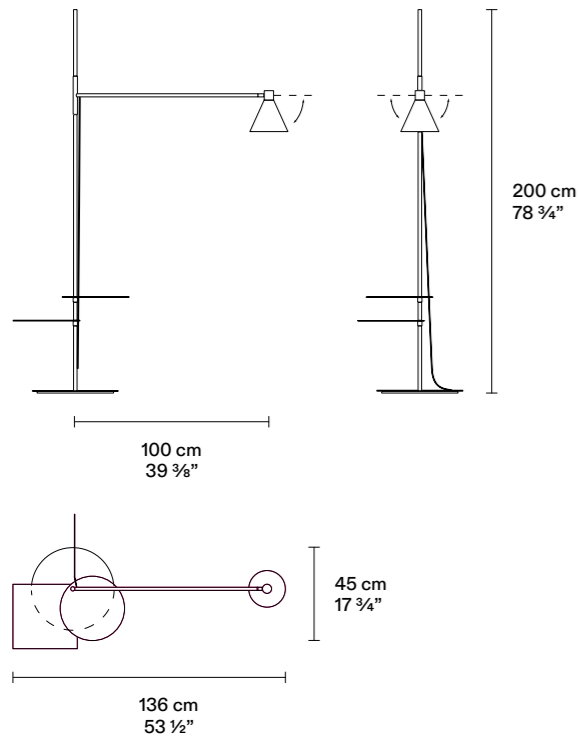

<b>Materiali</b> Materials	Acciaio, PVC elastico Steel, elastic PVC
<b>Finiture</b> Finishes	Nero opaco "soft touch" Matt black "soft touch"
<b>Categoria</b> Category	Da terra Floor
<b>Technical details</b> Specifiche tecniche	100÷240 V – 50/60 Hz 1x LED 8 W, 24 V, 2700K, CRI90
	IP20 □ ▲
<b>Controllo</b> Control	Dimmer integrato sul paralume Integrated dimmer on the lampshade
<b>Certifications</b> Certificazioni	CE

Wall version

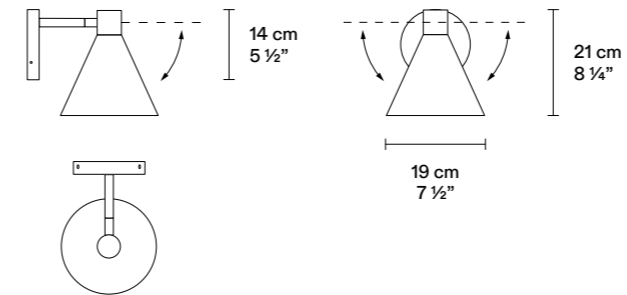

<b>Materiali</b> Materials	Acciaio, PVC elastico Steel, elastic PVC
<b>Finiture</b> Finishes	Nero opaco "soft touch" Matt black "soft touch"
<b>Categoria</b> Category	Da parete Wall
<b>Technical details</b> Specifiche tecniche	100÷240 V – 50/60 Hz 1x LED 8 W, 24 V, 2700K, CRI90
	IP20 □ ▲
<b>Controllo</b> Control	Dimmer integrato sul paralume Integrated dimmer on the lampshade
<b>Certifications</b> Certificazioni	CE

POET

Keiji Takeuchi











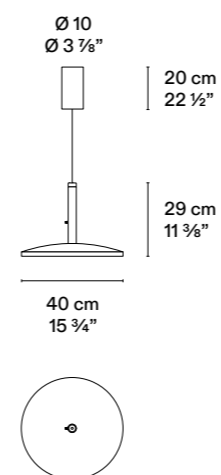

IT Poet è una lampada con una duplice prospettiva di illuminazione, a sospensione o da terra. Progetto del designer giapponese Keiji Takeuchi, evoca atmosfere di luci gentili grazie al design versatile di natura, che si delinea su un disco luminoso abbracciato da un cilindro.

EN Poet is a lamp with a dual lighting perspective, available as a pendant or floor version. Designed by Japanese designer Keiji Takeuchi, it evokes atmospheres of gentle light through its naturally versatile design, defined by a luminous disc embraced by a cylinder.



Pendant version

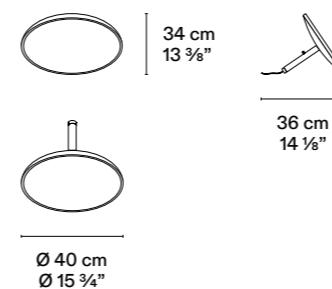

<b>Materiali</b> Materials	Metallo Metal
<b>Finiture</b> Finishes	Nero opaco Matt black
<b>Categoria</b> Category	Sospensione Pendant
<b>Technical details</b> Specifiche tecniche	100÷240 V – 50/60 Hz LED 36 W, 24 V, Tunable White 2700-5200K, CRI85
	IP20  
<b>Controllo</b> Control	Dimmer integrato nel rosone, tramite app CASAMBI Ceiling rose with integrated dimmer, via CASAMBI app
<b>Certificazioni</b> Certificazioni	

Floor/table version



<b>Materiali</b> Materials	Metallo Metal
<b>Finiture</b> Finishes	Nero opaco Matt black
<b>Categoria</b> Category	Da appoggio Floor/table
<b>Technical details</b> Specifiche tecniche	EU 220÷240 V – 50/60 Hz LED 36 W, 24 V, Tunable White 2700-5200K, CRI85  USA 100÷120 V – 50/60 Hz LED 36 W, 24 V, Tunable White 2700-5200K, CRI85
	IP20  
<b>Controllo</b> Control	Dimmer integrato nel corpo della lampada Integrated dimmer on the lamp body
<b>Certificazioni</b> Certificazioni	

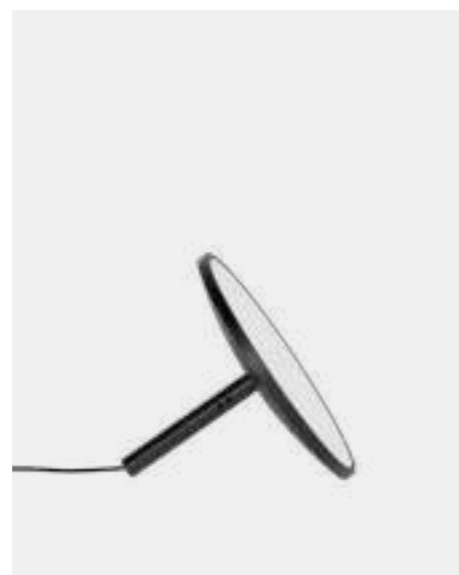

Pendant version

Floor/table version

TSUKI

Naoto Fukasawa







TSUKI  
Naoto Fukasawa, 2020

IT La perfezione di una mezza sfera, il segno materico e le suggestioni astrali. Il segreto della lampada da appoggio Tsuki, firmata dal designer giapponese Naoto Fukasawa, è nella semplicità del disegno e nella scelta dei materiali. Disponibile in marmo o cemento, è funzionale, efficiente, discreta. Vive da sola oppure posizionata in serie, creando suggestivi coni di luce.

EN The perfection of a half sphere, the textural design and astral moods. The secret of the Tsuki table lamp by Japanese designer Naoto Fukasawa lies in its simple design and choice of materials. Available in marble, it is functional, efficient and discreet. It can be used alone or positioned in a series, creating striking cones of light.

Floor/Table lamp

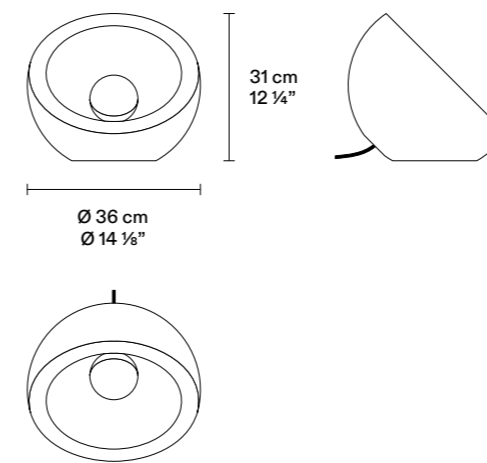

Materiali Materials	Cemento, marmo, vetro, alluminio Concrete, marble, glass, aluminium
Finiture Finishes	Cemento grigio chiaro Light grey concrete  Marmo Calacatta Calacatta marble
Categoria Category	Da appoggio Floor/table
Specifiche tecniche Technical details	EU 220÷240 V – 50/60 Hz LED 5 W, 3000K, CRI80 LED E27, max 20 W  USA 100÷120 V – 50/60 Hz LED 5 W, 3000K, CRI80 LED E26, max 20 W
Controllo Control	Dimmer integrato nel cavo di alimentazione Power cable with integrated dimmer
Certificazioni Certifications	CE UL CERTIFIED



Floor/Table lamp

**Certificazioni**  
Certifications



A norme Europee — Prodotto in accordo alla norma EN 60598 e rispondente alla direttiva BT 73/23/CEE e loro aggiornamenti.

According to European standards - The product complies with EN 60598 standard and BT 73/23/EEC directive with its updates.



Marchio di conformità agli standard elettrici e costruttivi USA/Canada.

Mark of compliance with the US/Canada electrical and construction standards.



Marchio di conformità agli standard elettrici e costruttivi USA/Canada.

Mark of compliance with the US/Canada electrical and construction standards.

**Classe di isolamento**  
Insulation Class



Classe I. Apparecchio con isolamento di sicurezza garantito dalla messa a terra.

Class I: electrical appliance relies on basic insulation and an earth (ground) connection to ensure safety.



Classe II. Apparecchio con doppio isolamento di sicurezza, senza messa a terra.

Class II: double insulated electrical appliance without safety earth grounding.



Classe III. Apparecchio con alimentazione a bassa tensione.

Class III: electrical appliance with extra-low voltage power source.

**Grado di protezione**  
Degree of protection



Il grado IP indica l'indice di protezione dalla penetrazione di corpi solidi (prima cifra) e di liquidi (seconda cifra).

The IP degree classifies the protection against the intrusion of solid bodies (first digit) and foreign liquids (second digit)



Protezione contro la penetrazione di corpi solidi fino a Ø 12 mm, nessuna protezione contro la penetrazione di liquidi.

Protection against solids up to 12 mm in diameter and no protection against liquids.



Protezione contro la penetrazione di corpi solidi fino a Ø 12 mm, protezione contro la caduta verticale di gocce d'acqua.

Protection against solids up to 12 mm in diameter and protection against vertically falling drops of water.



Protezione contro la penetrazione di polveri, protezione contro la penetrazione di spruzzi d'acqua da tutte le direzioni.

Protection against limited dust ingress and water sprays from all directions.



Protezione totale contro la penetrazione di polveri, protezione contro la penetrazione di getti d'acqua.

Complete protection against contamination from dust and against water jets.

**Controllo e dimmerazione**  
Control and dimming

CASAMBI

Permette di regolare l'intensità luminosa e la temperatura colore della luce (bianco dinamico) di apparecchi singoli o a gruppi, tramite app attivando il BLUETOOTH. Non è compatibile con altri sistemi di dimmerazione.

This system uses Bluetooth Low Energy to control lighting, allowing users to adjust light intensity and colour temperature (tunable white) of individual or grouped luminaires through a mobile app. Casambi is not compatible with other dimming systems.

0-10V

La dimmerazione 0-10V è un metodo analogico di attenuazione degli apparecchi di illuminazione che utilizza un segnale di tensione di controllo per regolare l'emissione luminosa da 0 a 100%. Non si può usare per il bianco dinamico.

0-10V dimming is an analog control systems that regulate light output from 0 to 100% through a low-voltage signal. This voltage range, from 0 to 10 volts, controls the brightness of the light. It's not typically used for tunable white lighting.

DALI

DALI è un protocollo di comunicazione digitale che consente di inviare comandi alle luci per accenderle, spegnerle, dimmerarle e creare scene di illuminazione predefinite. All'interno della lampada viene inserito un dimmer adatto a svolgere questa funzione.

DALI (Digital Addressable Lighting Interface) is a digital communication protocol used for controlling lighting, including switching on/off, dimming, and creating lighting scenes. A DALI-compatible dimmer is integrated within the lamp to perform these commands.

PUSH

Permette di regolare l'intensità luminosa tramite un pulsante a parete. All'interno della lampada viene inserito un dimmer adatto a svolgere questa funzione.

A PUSH dimming system allows you to adjust the brightness of a light using a simple push wall button. A dimmer specifically designed for this function is typically installed inside the lamp itself.

CUT-PHASE

La dimmerazione con taglio di fase è un metodo per controllare l'intensità luminosa interrompendo una parte della corrente alternata che alimenta la fonte luminosa.

Cut-Phase dimming is a technique used in dimmers to control the brightness of lights by interrupting or "cutting" a portion of the alternating current (AC) waveform before it reaches the lamp.

**Altri**  
Others



Lampadina non inclusa.  
Bulb not included.



Lampadina consigliata: Globo.  
Recommended bulb: Globe.



Lampadina consigliata Globo con bulbo argentato.  
Recommended bulb: Globe, silver-tipped bulb.



Apparecchio con illuminazione a LED integrato  
Appliance with integrated LED lighting.



Apparecchio dotato di batteria agli ioni di litio.  
Appliance equipped with lithium-ion battery.



Indice di resa cromatica: capacità della sorgente luminosa di riprodurre fedelmente i colori rispetto alla luce naturale (da 0 a 100).

The Colour Rendering Index is a quantitative measure of the ability of a light source to reveal the colours in comparison with a natural light source (scale from 0 to 100).

Specifiche dimmerazioni lampade  
Dimming specifications for lamps

Product	Category	Not included	Integrated in the cable	Touch	Casambi	DALI	PUSH	0-10V	Cut Phase
Abete	Pendant	●							
Andon	Floor	●							
Anna	Table		●						
Ava	Table		●						
Ava	Pendant	●							
Bombori	Table		●						
Bombori	Pendant	●				▲			
Cut Back	Wall			●					
Cut Back	Pendant				■	●	●	●	●
Cut Back	Floor			●					
Cut Back Up&Down	Floor To Ceiling			●					
Cut Back Linear	Pendant				■	●	●	●	●
Drop Paper Lamp	Table		●						
Drop Paper Lamp	Pendant	●				▲			
DT Light 25	Floor		●						
Elementi	Pendant				●	▲	▲		▲
Elementi	Table-Floor				●				
Firefly	Portable	●							
Giò	Pendant			●	■	■	■	■	
Helium	Table		●						
Helium	Floor		●						
Helium	Pendant				■	●	●	●	●
Helium	Wall				■	●	●	●	●
Helium Mini	Pendant				■	●	●	●	●
Helium Mini	Table		●						
Lantern	Table		●						
Lantern	Pendant	●				▲			
Lantia	Pendant				■	●	●	●	●
Lantia	Table-Floor		●						
L.O.P. without spere	Pendant	●				▲			
L.O.P. with sphere	Pendant	●				▲			
Linea D'Ombra	Table		●						
Linear Light System	Pendant				■	●	●		
Mogura	Floor	●							
Mogura	Pendant	●							
Nagoya	Floor-Table		●						
Naviglio	Pendant	●							
Nota	Floor-Wall			●					
Poet	Pendant				●	▲	▲		▲
Poet	Floor			●					
Tsuki	Floor/Table		●						

● Caratteristiche lampada standard  
Standard lamp features

■ Ordinabile a parte  
Can be ordered separately

▲ Ordinabile come speciale  
Can be ordered as a special

De Padova srl  
Via Santa Cecilia, 7  
20122 Milano, Italia  
T. +39 02 27 43 97 1  
info@depadova.it  
www.depadova.com

COLLECTIONS LIGHTING 2025

Creative Direction  
Boffi | DePadova

CATALOGUE

Creative Direction  
Davies Costacurta

Graphic Design  
Studio Costacurta

Rendering  
Nudesign

Photography  
Jeremias Morandell  
Stefano Galuzzi

Styling  
Greta Cevenini

Thanks to  
Argilleria Milanese di Morena Massera  
Imperfettolab  
Michela Grossi Sculpture  
Time & Style  
ZEE CERAMICS



ADI  
Compasso d'oro  
Maddalena De Padova  
Career Award 2004

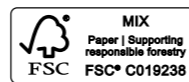

All rights reserved. No part of this catalogue may be reproduced or transmitted in any form or by any means, electronic or mechanical, including printing, photocopying, recording, or any information storage and retrieval system without prior permission in writing from De Padova s.r.l., excepting reproduction intended to support the sale of De Padova products privately. This catalogue is available free of charge subject to the condition that it shall not, by way of trade or otherwise, be sold or hired out totally or partly.

De Padova reserves the right to make modifications and improvements at any time to the products, fabrics and leathers that may vary from the solutions presented in this catalogue. We invite you to visit the website [www.depadova.com](http://www.depadova.com) to download technical information on the products.



At De Padova, light is not merely for exhibition, it's an opportunity to recount a new vision and see lighting as a design language and narrative tool.