



# Iconic living.



SINA ROLF BENZ

# 1964



Rolf Benz SINA, Arabic for “beauty”, stands for the modern reprise of the Rolf Benz icon Addiform from 1964. Six decades later, flexibility, functionality and a timeless design that creates space also form the basis of this iconic anniversary sofa that was inspired by the design classic that is as inviting as it is celebrated.

addiform

# 2024



Rolf Benz SINA guarantees a tailor-made living experience. It can be used equally as a focal point for unconventional ways of working, relaxed meetings, or as an inspiring cosy retreat for wonderful moments. In short, this sofa embodies everything that Rolf Benz stands for.

SINA ROLF  
BENZ

# Timeless **beauty.** Impressive facets.

The modular sofa system, in which all elements can stand alone or as a combination, easily becomes a contemporary focal point in the home without taking up too much space. Quite the contrary, Rolf Benz SINA presents itself as a reserved living landscape whose timeless design ensures it remains a captivating exceptional feature.

The unusual elegance of this design and its elevated craftsmanship are highlighted not least by its elaborate felled and decorative seams. An optional, horizontal Cacharel pleat along the backrest cushions exemplifies ultimate craftsmanship and is an eye-catching design that is both reserved and appealing at the same time. The soft seat cushions of Rolf Benz SINA rest on a frame that is available in leather or fabric with softly curved back and side sections.

Seat and backrest cushion covers in contrasting materials and colours create a modern mix of materials and the wealth of creative design possibilities here is seemingly endless.







Rolf Benz SINA | 002

Cover: 38.111 / 26.383



Rolf Benz SINA

Rolf Benz SINA | 003

Cover: 42.203 / 24.353



Rolf Benz SINA | 004

Cover: 38.105 / 26.387

- Modular sofa system – all elements can also be free-standing
- Different floor plan options for large and small-sized rooms
- New Mix & Match combination: seat and back cushions in one cover and the body in a different one
- Complementary, integrable occasional furniture (Rolf Benz 906 SINA coffee table and shelf)
- Backrest cushions with (optional) horizontal Cacharel pleat
- Connecting upholstered bench
- Optional backrest extension for perfect high-back comfort

- 3 seat heights: 42, 45 or 48 cm
- 2 seat depths: 56 or 67 cm
- 2 upholstery grades: Lounge Plus or Lounge Deluxe
- 2 leg finishes
- Made in Germany
- Design: Beck Design



Rolf Benz SINA | 005

Cover: 17.351 / 17.403 / 17.400

# Bespoke living for comfort.

Rolf Benz SINA creates inspiring spaces with a number of flexible modular elements. Innovative sofa modules that optionally come with only one backrest and the integrable Rolf Benz SINA coffee table create a sense of soothing transparency.

With the connected upholstered bench and the perfectly matching shelf, Rolf Benz SINA creates a sophisticated interplay of seating, reclining and storage options. Two different upholstery versions, two seat depths and three seat heights offer additional customisation options.





Rolf Benz SINA

006

Cover: 17.351 / 17.400



Rolf Benz SINA shelf | 007  
Finish: American walnut

Rolf Benz SINA

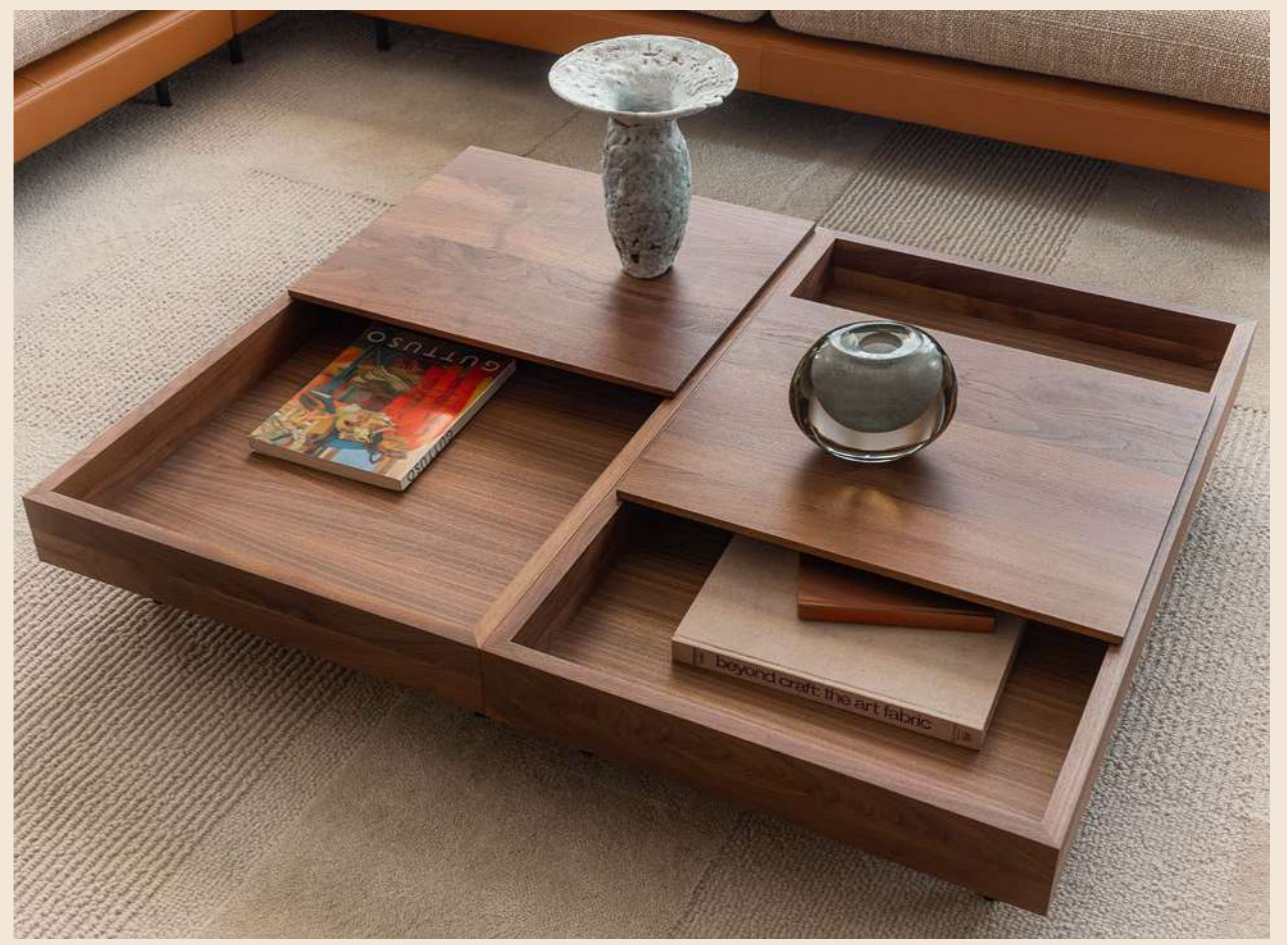

Rolf Benz SINA coffee table | 008  
Finish: American walnut



Rolf Benz SINA coffee table | 009  
Finish: Natural oak



Rolf Benz SINA shelf | 010  
Finish: Black oak



Rolf Benz PHIL

012

Cover: 26.382



Rolf Benz PHIL

013

Cover: 26.381



Rolf Benz ONNO



014

Parsol glass bronze

The simple elegance of the Rolf Benz PHIL club armchair, which perfectly complements the sofa, is impressive at first sight. Its soft upholstery contrasts with the surrounding steel frame. Taking a closer look reveals a detailed display of masterful craftsmanship.

With the Rolf Benz ONNO coffee and side table, transparent purism meets a captivating display of colour and form. Its organic silhouette and elegant finish create a timeless design with a clear edge.

# Technical data.

- Wooden inner frame
- Nosag spring support
- **Seating comfort „Lounge Plus“**  
 Seat with a layered structure with polyurethane foam and a highquality cold foam, coordinated with each other in terms of height and hardness, with a polyester fleece cover.
  - Back pad in polyurethane foam
  - Back cover quilted underneath with polyester nonwoven High-quality, casual upholstery that forms waves/leaves indentations that are typical of the material. All measurements are approximate.
- **Seating comfort „Lounge Deluxe“**  
 Seat made of polyurethane foam, built up in layers and coordinated in different thicknesses and hardnesses, covered with a pad consisting of 20 % viscose foam and 80 % microfibres.
  - Back pad in polyurethane foam
  - Upholstery cover glued-on non-woven polyester A high-quality, especially casual upholstery that forms waves/leaves indentations that are typical of the material - this waviness may even occur in new condition. All measurements are approximate.
- Down-like backrest cushions comprising compartments with a filling made of 100 % microfibres and a supporting core made of polyurethane
- Circular tubular leg, steel, fine structure, matt powdercoated, optionally:
  - Traffic black RAL 9017
  - Umbra grey RAL 7022
- Seat height options 42, 45 or 48 cm

Normal seat depth

Extra-deep seat depth



SOB 60/SB 168

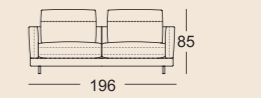
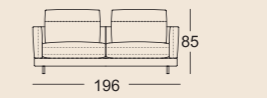

SOB 60/SB 189

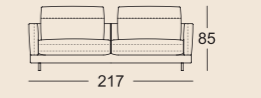
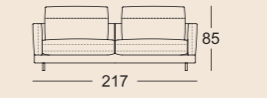

SOB 60/SB 210

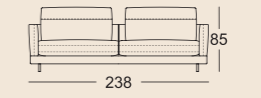
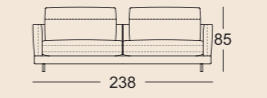

ASO 60/SB116\*

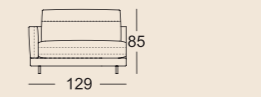
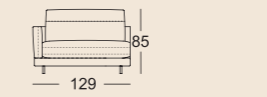

ASO 60/SB 168\*

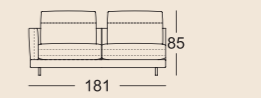
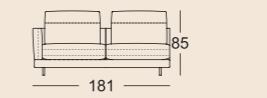

ASO 60/SB189\*

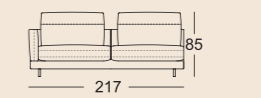
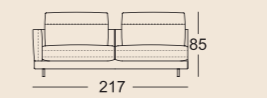

ASO 60/SB 210\*

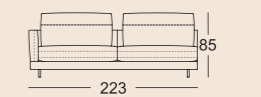
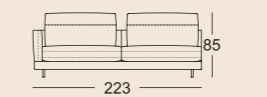

ASS-PSZ-RA 60/SB 105\*

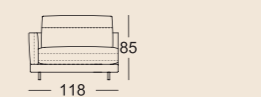
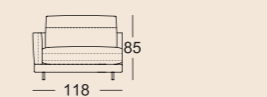

ASS-PSZ-RA 60/SB 116\*

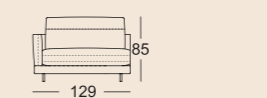

E-ASO 60/SB168\*

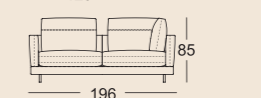
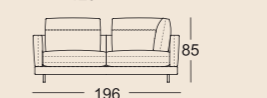

E-ASO 60/SB189\*

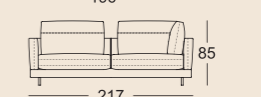
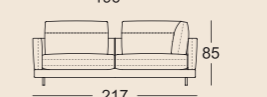

E-ASO 60/SB210\*

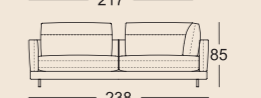
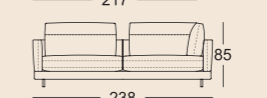

E-ASO-RA 60/SB168\*

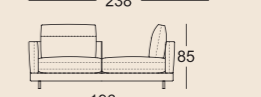
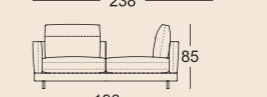

E-ASO-RA 60/SB 189\*

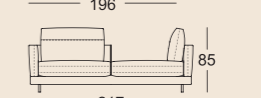
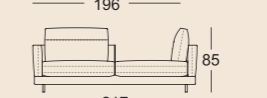

E-ASO-RA 60/SB210\*

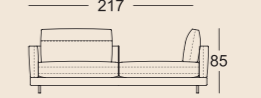
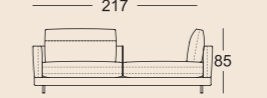

Important note: The backrest cushions are available with or without a transverse Cacharel pleat (decorative stitching).  
 \*These elements are only shown in the left version. They are also available in the right version.



3 Seat heights available

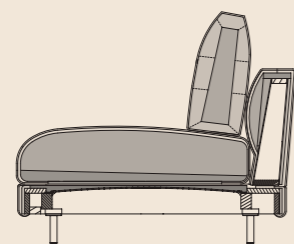

Lounge Plus

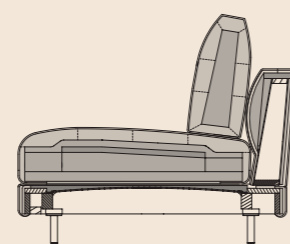

Lounge Deluxe

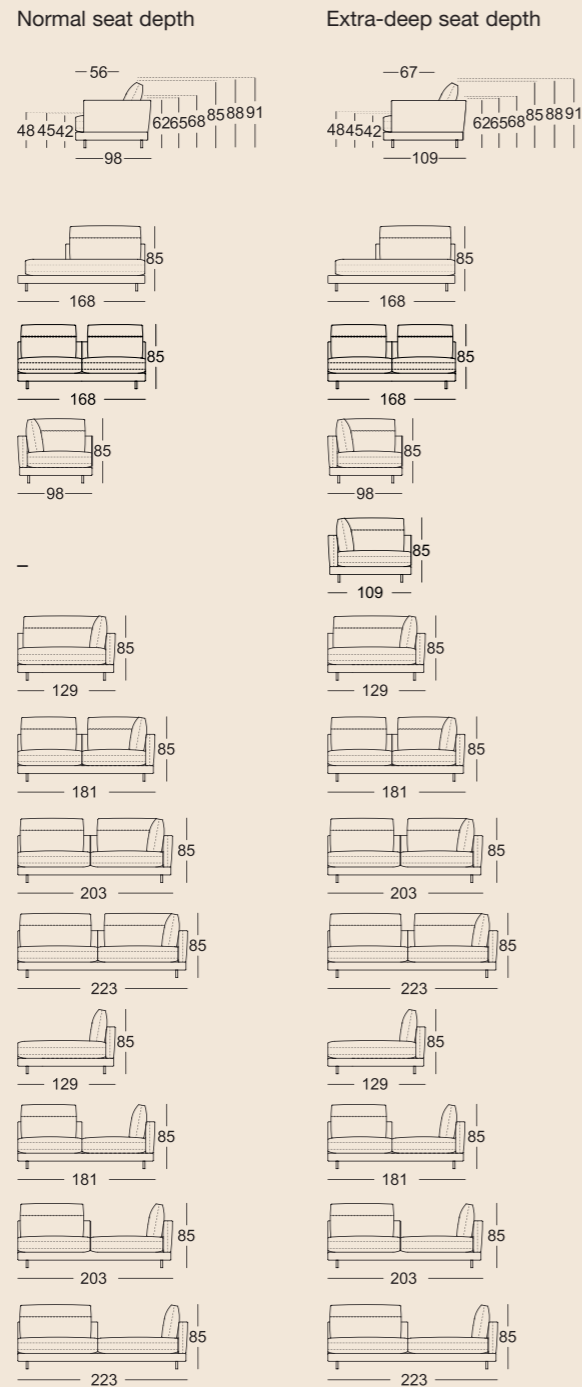

ARB-PSZ-RA 60/SB158\*

ARB 60/SB168

EPT 60/SB84\*

UE-EPT 60/SB95x95\*

E-ARB 60/SB116\*

E-ARB 60/SB168\*

E-ARB 60/SB189\*

E-ARB 60/SB210\*

E-ARB-RA 60/SB116\*

E-ARB-RA 60/SB168\*

E-ARB-RA 60/SB189\*

E-ARB-RA 60/SB210\*

Important note: The backrest cushions are available with or without a transverse Cacharel pleat (decorative stitching).

\*These elements are only shown in the left version. They are also available in the right version.

Modular upholstered bench element

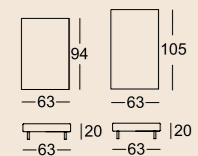

Seat cushion modular upholstered bench element

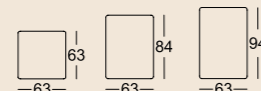

Low back cushion



Back cushion mat



Backrest extension

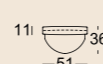

Side cushion with or without decorative stitching



Headrest



# Combination examples.

## Combination longchair

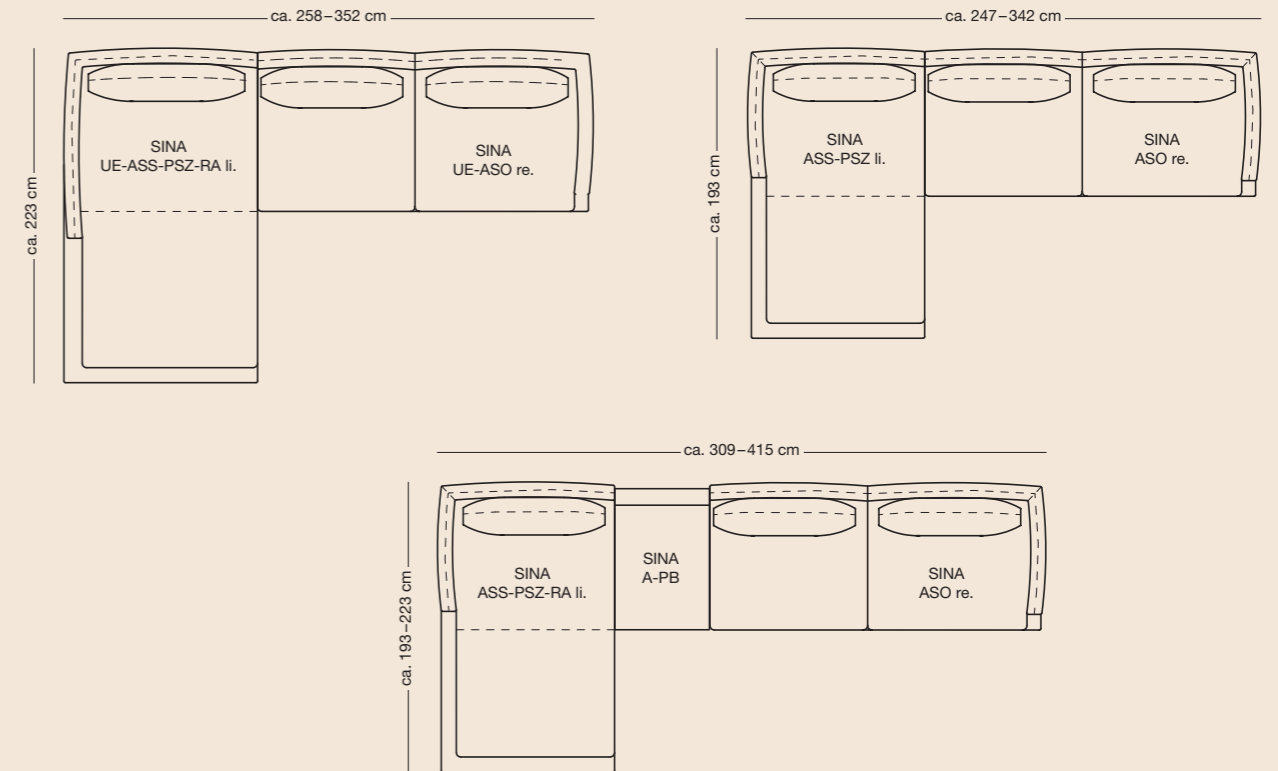

## Corner

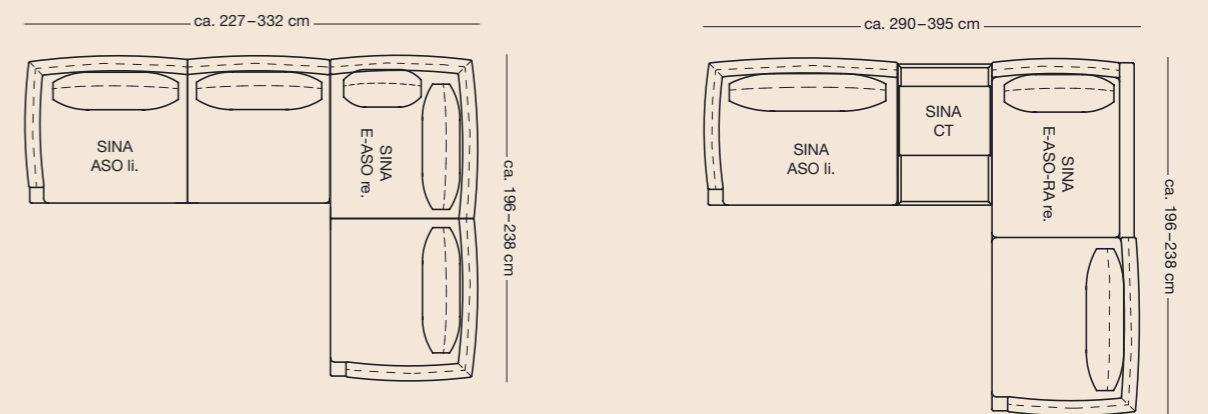

# Combination examples.

## Corner

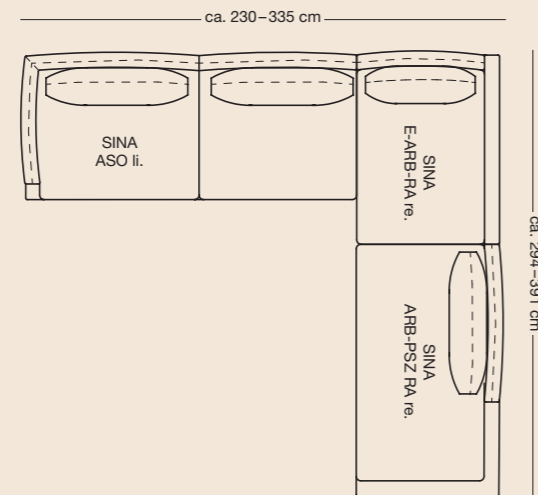

## Landscape

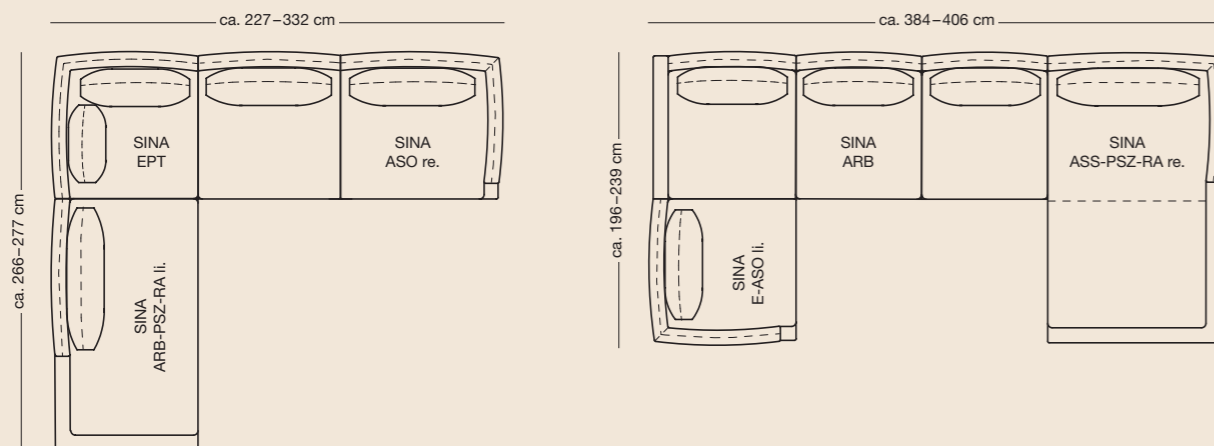

# Complementary.



## Rolf Benz 906 SINA

**Coffee table**  
(free-standing or connecting)

Dimensions:

- 63 x 94 cm or 63 x 104,5 cm
- Height 21, 24 or 27 cm

Leg design: steel, fine structure, matt powder-coated, optionally:

- Traffic black RAL 9017
- Umbra grey RAL 7022

## Shelving

Dimensions:

- 84 x 34 cm, height 46 cm

(without tray 84 x 24 cm, height 44 cm)

The shelf rests on a base.

## Body

Solid wood, varnished, optionally:

- Natural oak
- Stained black oak
- American walnut



## Rolf Benz ONNO

**Coffee table**

Dimensions:

- 53 x 58 cm, height 37 cm

## Side table

Dimensions:

- 39 x 38 cm, height 43 cm

Parsol glass, optionally:

- Grey
- Bronze



## Rolf Benz 585 PHIL

Foamed steel shaft spring system seat and backrest with metal internal frame, foam-moulded, cover quilted with polyester fleece

High-quality, casual upholstery that forms waves/leaves indentations that are typical of the material. All measurements are approximate.

## Leg versions

Metal frame or circular tube leg, steel, fine structure, matt powder-coated, optionally:

- RAL 9017 Traffic black
- Marrone metallic

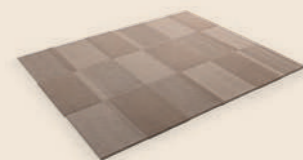
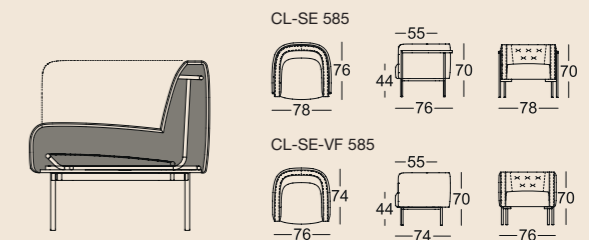

## Rolf Benz LIVELLO

Three different yarn structures in individual fields blend together to create a harmonious image.

Pure new wool, optionally:



Colour 501:  
Grey

Colour 502:  
Cappuccino

Colour 503:  
Sand

All technical information in this brochure is based on the period prior to printing; this information may have changed subsequently. The colours may vary for technical reasons during printing. Please refer to the samples that are available.

[www.rolf-benz.com](http://www.rolf-benz.com)

**ROLF  
BENZ**